

**SOFAR**

# **USER MANUAL**

**ESI 3~6K-S1-HA1~6**

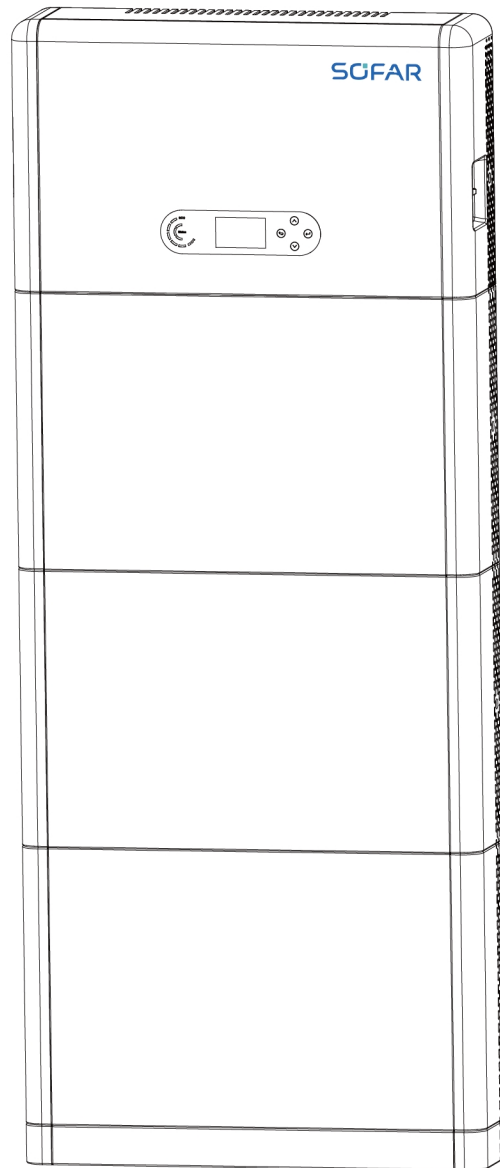

Shenzhen SOFARSOLAR Co., Ltd

## Contents

Preface .....	III
1. Basic Safety Information .....	1
1.1. Requirement for Installation and Maintenance .....	1
1.2. Symbols and signs .....	6
2. Product Introduction .....	9
2.1. Product overview .....	9
2.2. Product Model Description .....	10
2.3. Product Capacity Description .....	12
2.4. Product Appearance .....	15
2.5. Buttons and indicator lights .....	17
2.6. Product label .....	19
3. Product Installation .....	21
3.1. Checking Before Installation .....	21
3.2. Installation Tools .....	26
3.3. Installation environment .....	28
3.4. Installation Space .....	29
3.5. Product Installation .....	31
4. Electrical Connection .....	35
4.1. Attentions Before Connection .....	35
4.2. Preparation of Connection Cables .....	35
4.3. Electrical Connection for Internal System .....	36
4.4. External Electrical Connection .....	40

---

4.5. Install the cover .....	57
4.6. Parallel system .....	58
4.7. System Electrical Topology .....	60
5. Commissioning .....	62
5.1. Checking Before System Starting .....	62
5.2. Electrify for the First Time (Important) .....	62
5.3. Menu .....	65
6. Trouble shooting and maintenance .....	82
6.1. Troubleshooting .....	82
6.2. Daily Maintenance .....	96
6.3. Store and charge the battery module .....	96
7. Technical Parameters .....	99
8. Manufacturer's Warranty and Liability Terms .....	104

# Preface

## Notice

The products, services or features you purchased shall be subject to the company's commercial contracts and terms. All or part of the products and services described in this document may not within the scope of your purchase. Unless additional terms and conditions in your contract, the company does not make any statement or guarantee on the contents of this document. In addition, the term "Product" as described in this document refers broadly to "ESI Series products"

## Save this Instruction

This manual must be considered as an integral part of the equipment. Customer can print the electronic version to hard copy and keeping properly for future reference. Anyone who operates the device at any time must operate in accordance with the requirements of this manual.

## Copyright Declaration

The copyright of this manual belongs to SHENZHEN SOFARSOLAR Co., Ltd. Any corporation or individual should not plagiarize, partially cope or fully copy (including software, etc.), not allow to duplication and publishment in any form and any way. All rights reserved, SOFARSOLAR reserves the right of final interpretation. This manual subject to modify according to user's or customer's feedback. Please check our website at <http://www.sofarsolar.com> for lasted version.

The scope of use and warranty is only applicable to mainland China.

## Document Updates

V2.0 2023-2-20

- Initial version



- **Outline**

Please read the product manual carefully before installation, operation or maintenance. This manual contains important safety instructions and installation instructions that must be followed during installation and maintenance of the equipment.

- **Scope of Validity**



This product manual describes the installation, electrical connections, commissioning, maintenance and troubleshooting of ESI Series products.



- **Target Group**

This manual is for qualified electricians. The tasks described in this manual only can be performed by qualified electricians.

- **Symbols Used**

The following types of safety instruction and general information appear in this document as described below:

 <b>Danger</b>	“Danger” indicates a hazardous situation which, if not avoided, will result in death or serious injury.
 <b>Warning</b>	“Warning” indicates a hazardous situation which, if not avoided, could result in death or serious injury
 <b>Caution</b>	“Caution” indicates a hazardous situation which, if not avoided, could result in minor or moderate injury

	<p>“Attention” indicates there are potential risks, if fail to prevent, may lead to equipment cannot normally or property damage.</p>
Attention	
	<p>“Note” provides additional information and tips that are valuable for the optimal operation of the product, will help you to solve a problem or save your time.</p>
Note	

# 1. Basic Safety Information

## Outlines of this Chapter

Please read the instruction carefully. Faulty operation may cause serious injury or death .

 Note	If you have any question or problem when you read the following information, please contact SHENZHEN SOFARSOLAR CO., Ltd.
---	---

## 1.1. Requirement for Installation and Maintenance

### Common Requirements

The product must be installed in full compliance with national and local power grid standards and regulations.

Before installing and adjusting the produce, please read all of instructions, cautions and warnings in this manual

Before connecting the product to the electrical utility grid, contact the local utility company for allowance. Also, this connection must be made only by qualified electrician.

When any maintenance or repair is required, please contact the nearest authorized maintenance center. If you don't know which service center is closest to you, please contact your local distributor. Don't repair the product by yourself, which may lead serious injury or damage.

Before installing and maintaining the device, using the DC switch to cut off the high voltage direct current of the photovoltaic array. Otherwise, the high voltage may cause

---

serious injury.

- ✧ The product should be placed in a well-ventilated place. Do not place the product in a sealed or air-tight position or cabinet, otherwise it will affect the operation performance and system life of the energy storage system.
- ✧ Avoid direct sunlight. Do not place this product near stoves and fire sources. Otherwise, the lithium battery in the product system will leak or even explode.
- ✧ The maintenance personnel of this product must understand the knowledge and skills related to inverter and battery maintenance.
- ✧ ESI Series products are transformerless inverter which requires the positive pole and negative pole of the PV array are NOT grounded. Otherwise, it will cause inverter failure. In the PV system, all non-current-carrying metal parts (such as mounting frame, combiner box enclosure, etc.) should be connected to earthed.
- ✧ Reminder: Do not disassemble and destroy the battery. The toxic electrolyte in the battery can damage your skin and eyes.
- ✧ Caution: Comply with the following requirements during the installation and maintenance of the product:
  - ✧ A) Remove watches, rings and other metal objects from your body.
  - ✧ B) Use tools with insulated handles.
  - ✧ C) Wear rubber gloves and shoes.
  - ✧ D) Do not place tools or metal objects on the battery.
  - ✧ E) Close the inverter before connecting/disconnecting the battery and the energy storage inverter.
  - ✧ F) Battery +/- pole shall be isolated from ground.
- ✧ Installation and maintenance personnel requirements

- ✧ When the product is in the running state, some parts may be electrified and hot. Improper use, improper installation or operation may result in serious injury to person or property. Transport, loading, unloading, installation, start-up and maintenance operations must be performed by a qualified electrical engineer (all accident precautions in force in the user's country must be followed!) SOFARSOLAR will not be responsible for any personal injury or property injury caused by improper use.
- ✧ Installation location requirement
- ✧ Please install the product according to the following section. Place inverter in an appropriate bearing capacity objects (such as solid brick wall, or strength equivalent mounting surface, etc.) and make sure inverter vertical placed. A proper installation location must have enough space for fire engine access in order for maintenance if faulty occur. Ensure the inverter is installed in a wall ventilated environment and have enough air cooling cycle. Air humidity should less than 90%.

### **Transportation Requirement**

Inverter is in the good electrical and physical condition when it ship out from factory. During transport, inverter must be placed in its original package or other proper package. Transportation company should responsible for any damage during transport period.

If you find any packing problems that may cause the damage of inverter or any visible damage, please notice the responsible transportation company immediately. You can ask your installer or SOFARSOLAR for help is necessary.

This product contains battery module through UN38.3, belongs to the ninth category of dangerous goods. Therefore, loading and unloading must comply with local laws and regulations and industry standards during transportation. Rough loading and unloading may cause short circuit or damage to batteries in containers, which may result in battery leakage, breakage, explosion, or fire.



### Transportation Requirement

- ✧ Shipping complies with the IMDG CODE and the International Maritime Dangerous Goods CODE.
- ✧ For land transportation, comply with ADR or JT T617 shipping requirements
- ✧ Meet the regulatory requirements of the transport regulatory authorities of the country of origin, route and destination.



Comply with international regulations for the transport of dangerous goods and the supervision requirements of the corresponding national transport regulatory authorities.

### Electrical Connection



Please comply with all the current electrical regulations about accident prevention in dealing with the current inverter.

	Before the electrical connection, use opaque material to cover the PV modules or disconnect PV string DC switch. PV arrays will produce dangerous voltage if it is exposure under sun. When installing a battery, check the positive and negative terminals of the battery and turn off the battery.
<b>Danger</b>	
	All operation must accomplish by certified electrical engineer <ul style="list-style-type: none"> <li>● Must be trained;</li> <li>● Completely read the manual operation and understand all information.</li> </ul>
<b>Warning</b>	
	Must get permission by local utility company before connecting to grid and the connection must be done by certified electrical engineers.
<b>Attention</b>	

### Operation Cautions

	<p>Touching the utility grid or the terminal conductors can lead to lethal electric shock or fire!</p> <p>Do not touch non-insulated cable ends, DC conductors and any live components.</p>
<b>Danger</b>	<p>Attention to any electrical relevant instruction and document.</p>
	<p>Enclosure or internal components may get hot during operation. Please wear insulated gloves.</p>
<b>Attention</b>	

## Maintenance and Repair Cautions

	<p>Before any repair work, turn OFF the AC circuit breaker between the product and electrical grid first, then turn OFF the DC switch. After turning OFF the AC circuit breaker and DC switch wait for at least 5 minutes before carry any maintenance or repair work.</p>
<b>Danger</b>	
	<p>Product should not work again until removing all faults. If any repair work is required, please contact local authorized service centre. Should not open the product cover without authorized permit, SOFARSOALR does not take any responsibility for that.</p>
<b>Attention</b>	





## EMC/Noise Level

Electromagnetic compatibility (EMC) refers to that on electrical equipment functions in a given electromagnetic environment without any trouble or error, and impose no unacceptable effect upon the environment. Therefore, EMC represents the quality characters of an electrical equipment.

- The inherent noise-immune character: immunity to internal electrical noise
  - External noise immunity: immunity to electromagnetic noise of external system
- Noise emission level: influence of electromagnetic emission upon environment

	<p>Electromagnetic radiation from the product may be harmful to health! Please do not continue to stay away from the product in less than 20cm when it is working</p>
<b>Danger</b>	

## 1.2. Symbols and signs









	<p>High voltage of inverter may be harmful to health! Only certified engineer can operate the product; Juveniles, Disable, should not use this product; Keep this product out of the reach of children;</p>
<b>Danger</b>	
	<p>Caution of burn injuries due to hot enclosure! Only touch the screen and pressing key of the product while it is working</p>
<b>Caution</b>	
	<p>PV array should be grounded in accordance to the requirements of the local electrical grid company</p>
<b>Attention</b>	
	<p>Ensure the maximum DC voltage input is less than the product's maximum DC voltage (including in low temperature condition). Any damage cause by over-voltage, SOFARSOLAR will not take the responsibility including warranty</p>
<b>Warning</b>	

The product has some safety symbols on it. Please read and fully understand the content of the symbols before installation.

### Sings on the inverter module

Symbols	Name	Explanation
	<p>This is a residual voltage in the inverter module!</p>	<p>After disconnect with the DC side, there is a residual voltage in the inverter module, operator should wait for 5 minutes to ensure the capacitor is completely discharged.</p>



	<p>Caution of high voltage and electric shock</p>	<p>The inverter module operates at high voltages. Prior to performing any work on the product, disconnect the product from voltage sources. All work on the product must be carried out by qualified persons only.</p>
	<p>Caution of hot surface</p>	<p>The inverter module can get hot during operation. Avoid contact during operation. Prior to performing any work on the product, allow the product to cool down sufficiently</p>
	<p>Comply with European standard (CE) certification</p>	<p>The product comply with the CE Certification</p>
	<p>Grounding Terminal</p>	<p>Connect the inverter module to the ground bar for grounding protection</p>
	<p>Observe the documentation</p>	<p>Read all documentation supplied with the product before install</p>
	<p>Positive pole and negative pole</p>	<p>Positive pole and negative pole of the input voltage (DC)</p>
	<p>Temperature</p>	<p>Indicated the temperature allowance range</p>
	<p>This side up</p>	<p>Inverter must always be transported, handled and stored in such a way that the arrows always point upwards.</p>

	<p>RCM (Regulatory Compliance Mark)</p>	<p>The product complies with the requirements of the applicable Australian standards</p>
--	---	--

## Sings on the battery module

Symbols	Name	Explanation
	<p>This is a residual voltage in the battery module!</p>	<p>After the battery is powered on, there is a high voltage. After the battery is powered off, the internal capacitor is still charged, operator should wait for 5 minutes to ensure the capacitor is completely discharged.</p>
	<p>Caution of high voltage and electric shock</p>	<p>The inverter module operates at high voltages. Prior to performing any work on the product, disconnect the product from voltage sources. All work on the product must be carried out by qualified persons only.</p>
	<p>Caution of hot surface</p>	<p>The inverter module can get hot during operation. Avoid contact during operation.</p>
	<p>Grounding Terminal</p>	<p>Connect the battery module to the ground bar for grounding protection</p>
	<p>Observe the documentation</p>	<p>Read all documentation supplied with the product before install</p>

---

## 2. Product Introduction

### 2.1. Product overview

#### 2.1.1. Product brief introduction

ESI series single-phase household energy storage system consists of inverter module and lithium battery module. It adopts modular design and can be stacked with building blocks. The battery capacity ranges from 5kWh to 30kWh. The system can manage the energy of photovoltaic, battery, utility grid and load according to the actual application, and realize the optimal distribution of system energy. Multiple working modes are available to meet diverse needs.

The main features are as follows:

- Stack integrated design, convenient installation, simple maintenance;
- Built-in battery pack equalization management unit to improve battery available capacity;
- Photovoltaic maximum input current 16A, applicable to large current and double-sided module;
- Battery side complete electrical isolation, safer system;
- UPS function to ensure the stable operation of critical load;
- Supports a mixture of new and old batteries;
- Supports battery switch off with a button;

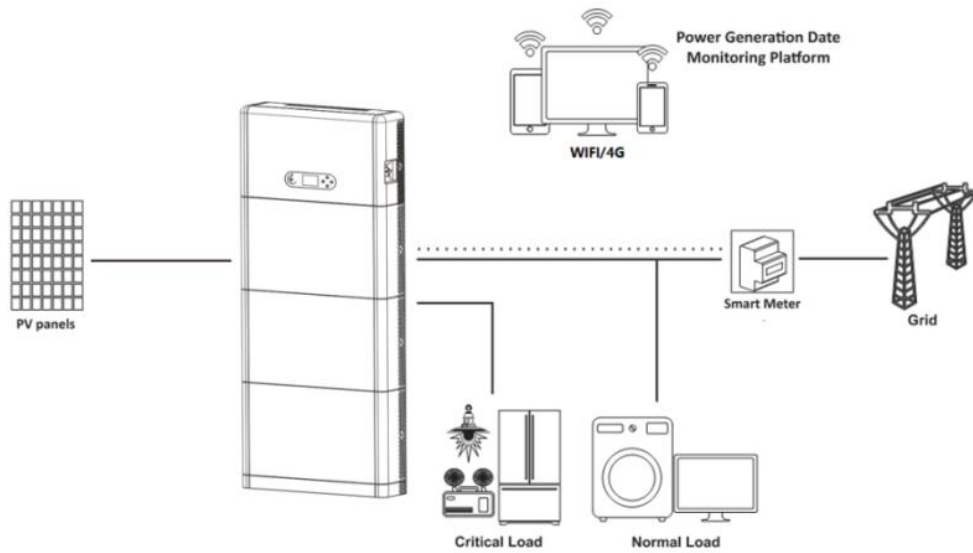

Figure 2.1.1-1 ESI series application principle diagram

## 2.2. Product Model Description

ESI series inverter model:



Figure 2.2-1 Inverter Model Identifiers

Table 2.2-1 Inverter Model demonstration

Identifiers	Meaning	Specification
①	Product Model	Stacked optical storage all in one machine
②	Power Grade	5K, the power grade of inverter is 5kw Power grade list: 3kw/3.68kw/4kw/4.6kw/5kw/6kw

③	Inverter Model	Single-phase hybrid energy storage inverter
---	----------------	---

ESI series battery module model:

**BTS 5K**  

---

①
②

Figure 2.2-2 Battery module model identifiers

Table 2.2-2 Battery module model demonstration

Identifiers	Meaning	Specification
①	Product series name	SOFARSOLAR BTS series battery module name
②	Battery module power grade	5K: Battery module power is 5kWh

ESI series system model:

**ESI 6K-S1-HA3**  

---

①
②
③
④

Figure 2.2-3 Model identifiers

Table 2.2-3 Model demonstration

Identifiers	Meaning	Specification
①	Product category	Stacked optical storage all in one machine
②	Power grade	6K, the power grade of inverter is 6kw
③	Inverter model	Single-phase hybrid energy storage inverter
④	Battery module quantity	HA3 means 3 battery modules



### 2.3. Product Capacity Description

The ESI series residential energy storage system supports power and capacity expansion and supports up to six inverter modules in parallel. One inverter module supports up to six batteries expansion modules.

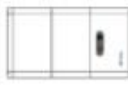
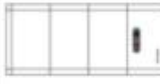
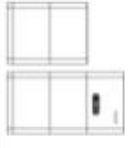

Figure 2.3-1 Storage Capacity Description

Table 2.3-1 ESI series product model list

Picture						
	ESI 3K-S1-HA					
ESI 3.68K-S1-HA	ESI 3.68K-S1-HA2	ESI 3.68K-S1-HA3	ESI 3.68K-S1-HA4	ESI 3.68K-S1-HA5	ESI 3.68K-S1-HA6	
ESI 4K-S1-HA	ESI 4K-S1-HA2	ESI 4K-S1-HA3	ESI 4K-S1-HA4	ESI 4K-S1-HA5	ESI 4K-S1-HA6	
ESI 4.6K-S1-HA	ESI 4.6K-S1-HA2	ESI 4.6K-S1-HA3	ESI 4.6K-S1-HA4	ESI 4.6K-S1-HA5	ESI 4.6K-S1-HA6	
ESI 5K-S1-HA	ESI 5K-S1-HA2	ESI 5K-S1-HA3	ESI 5K-S1-HA4	ESI 5K-S1-HA5	ESI 5K-S1-HA6	
ESI 5K-A-S1-HA	ESI 5K-A-S1-HA2	ESI 5K-A-S1-HA3	ESI 5K-A-S1-HA4	ESI 5K-A-S1-HA5	ESI 5K-A-S1-HA6	
ESI 6K-S1-HA	ESI 6K-S1-HA2	ESI 6K-S1-HA3	ESI 6K-S1-HA4	ESI 6K-S1-HA5	ESI 6K-S1-HA6	



## 2.4. Product Appearance

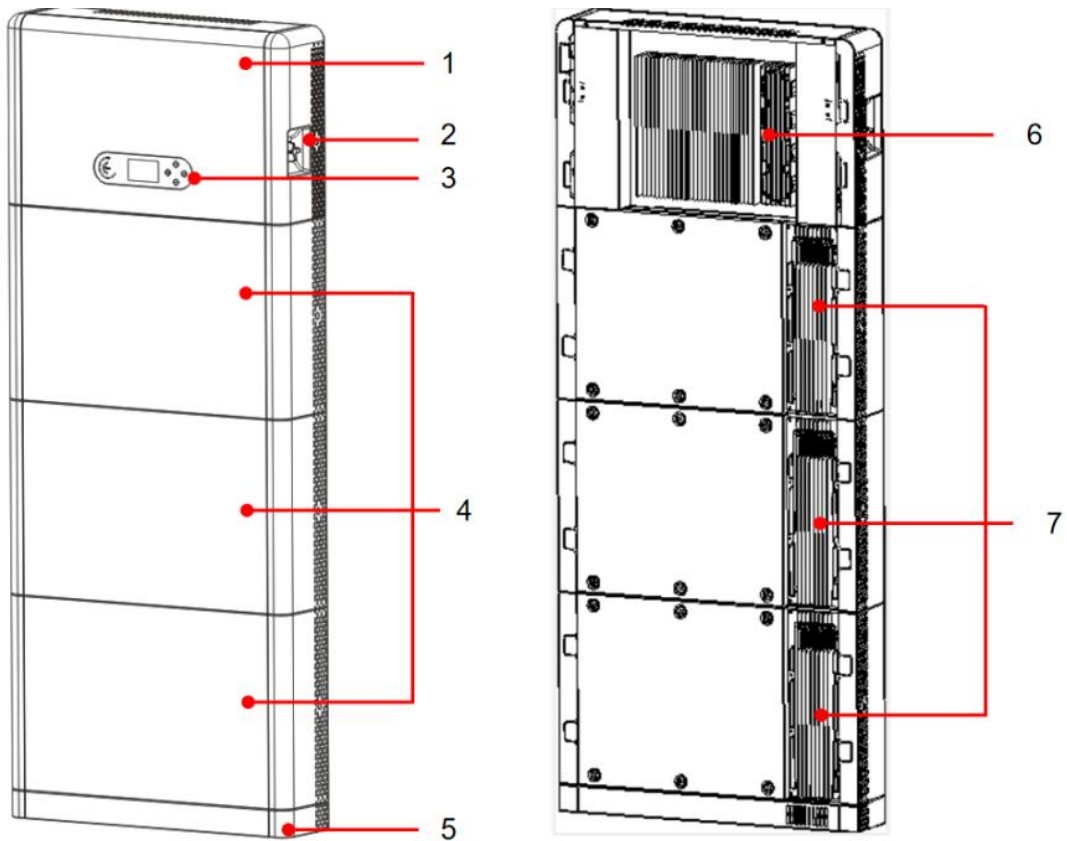

Front Side

Back Side

Figure 2.4-1 Product front side and back side

- |            |                     |                           |                  |
|------------|---------------------|---------------------------|------------------|
| 1 Inverter | 2 DC Switch         | 3 LCD display screen      | 4 Battery Module |
| 5 Pedestal | 6 Inverter Radiator | 7 Battery Module Radiator |                  |

### 2.4.1. Inverter Port

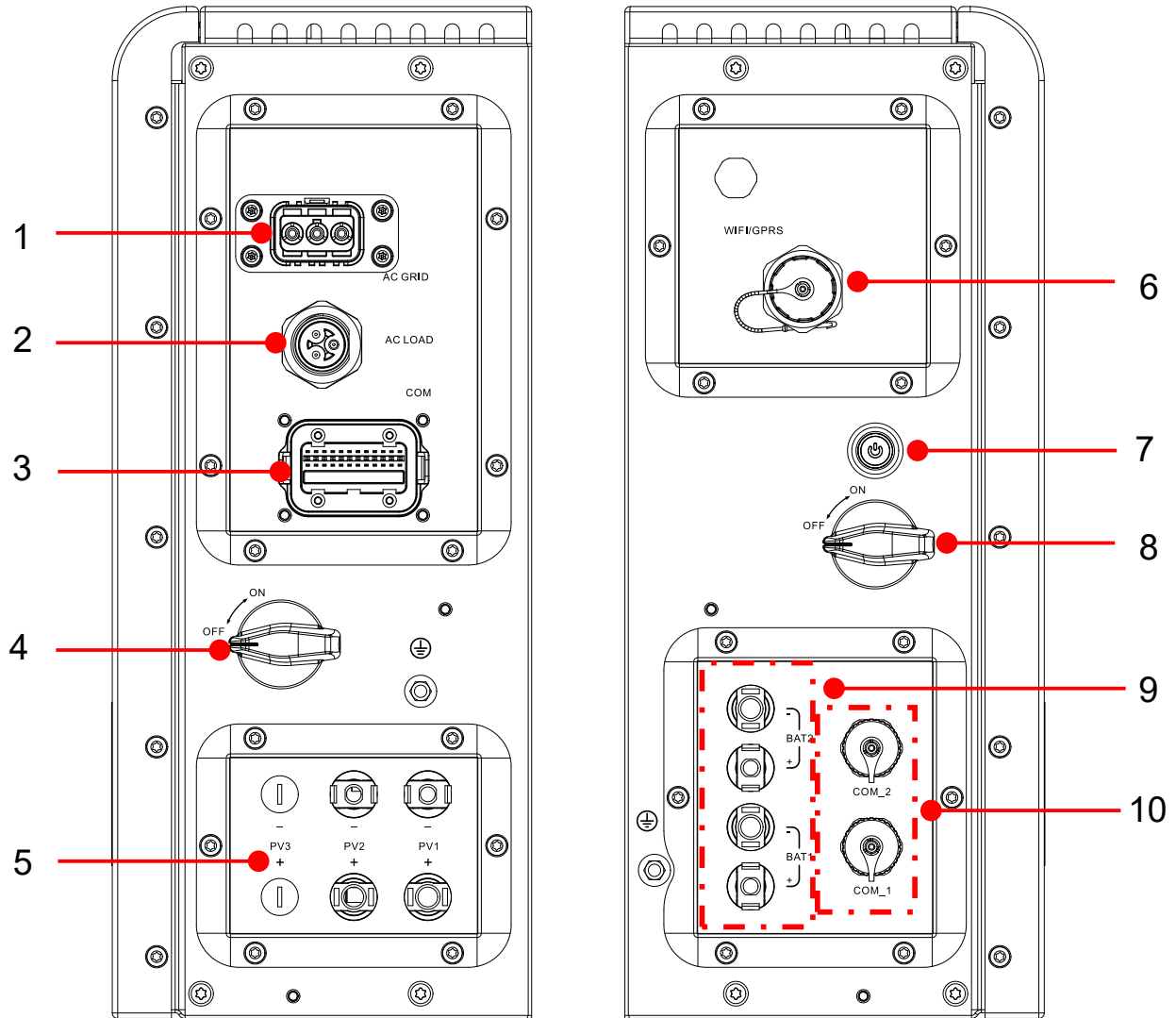

Right side port

Left side port

Figure 2.4.1-1 Inverter port diagram

- 1 Grid connection port      2 Load connection port      3 Inverter signal port      4 DC Switch
- 5 PV input port              6 WIFI/4G port              7 Battery black start switch
- 8 Battery input switch      9 Battery connection port      10 Battery signal port

### 2.4.2. Battery module port

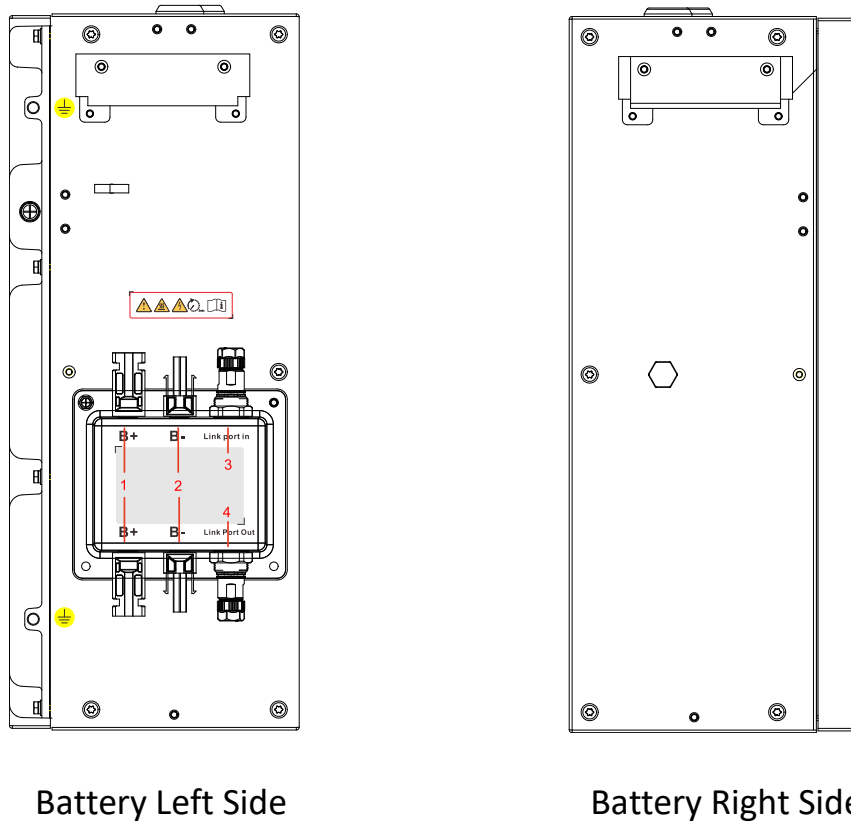

Figure 2.4.2-1 Battery module port diagram

1 Battery output terminal +    2 Battery input terminal -    3 Link Port In    4 Link Port Out

### 2.5. Buttons and indicator lights

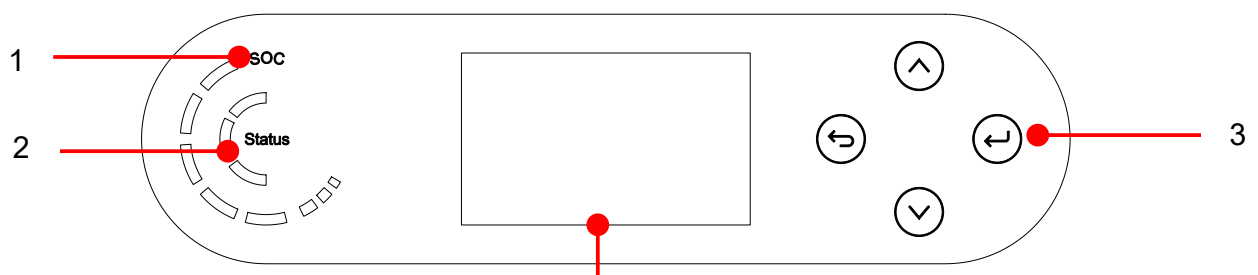





Figure 2.5-1 But <sup>4</sup> and indicator lights

1 System power indicator 2 System status indicator 3 Buttons 4 LCD screen



## 2.5.1. Buttons



- ✧ Press  “back” to the previous screen or enter the main interface.
- ✧ Press  “up” to the upper menu option or value plus 1.
- ✧ Press  “down” to the lower menu option or value minus 1.
- ✧ Press  “ok” to select the current menu option or switch to the next digit.

## 2.5.2. System status indicator

System Status	Indicator		
	Blue light	Green light	Red light
On-grid	ON		
Standby(On-grid)	Flashing		
Off-grid		ON	
Alarm			Flashing

## 2.5.3. Battery capacity indicator

Icon	Battery capacity	Capacity explanation
	80%-100%	The battery capacity is full
	60%-80%	

	40%-60%	
	20%-40%	
	0-20%	The battery capacity is insufficient, and the battery generates a low voltage alarm.

## 2.6. Product label

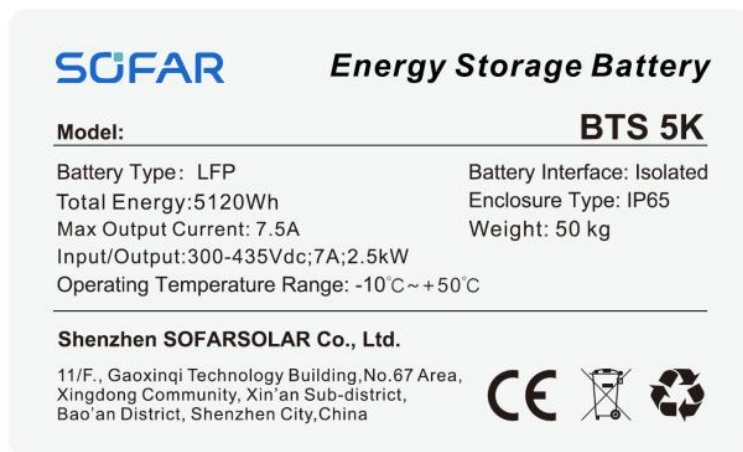

Figure 2.6-1 Battery module label

SOFAR Inverter Module	
Model No:	ESI 6K-S1
Max. DC Input Voltage	550V
Operating MPPT Voltage Range	85~520V
Max. PV Isc	2x22.5A
Rated Battery Voltage	400V
Max. Charging/Discharging Current	20A
Max. Charging/Discharging Power	6000W
Rated Grid Voltage	230V, 50/60Hz
Rated Output Voltage	230V, 50/60Hz
Max. Output Current	30A
Power Factor	1 (adj. +/-0.8)
Rated Output Power	6000W
Backup Rated Current	26A
Backup Rated Apparent Power	6000VA
Ingress Protection	IP65
Operating Temperature Range	-10 ~ +50°C
Protective Class	Class I
Inverter Topology	Non-Isolated
Overvoltage Category	AC III, DC II
Manufacturer: Shenzhen SOFARSOLAR Co., Ltd. Address: 11/F., Gaoxinqi Technology Building, No.67 Area, Xingdong Community, Xin'an Sub-district, Bao'an District, Shenzhen City, China VDE-AR-N4105 G99, AS/NZS 4777	

Figure 2.6-2 Inverter label

## 3. Product Installation



### 3.1. Checking Before Installation



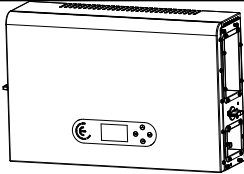

#### Checking Outer Packing Materials

Before opening the battery and inverter package, check whether the outer package is damaged, such as holes and cracks, and check the inverter and battery model. If any damage is found or the inverter and battery model does not match your requirements, please do not open the product package and contact your distributor as soon as possible.

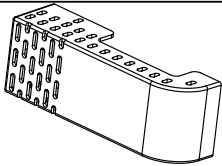

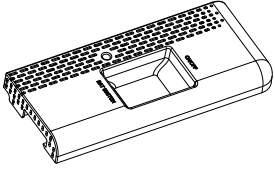
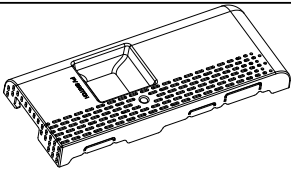

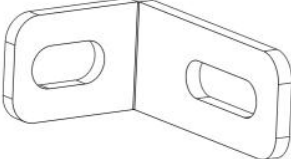
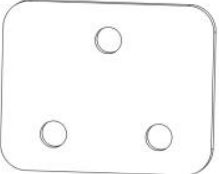
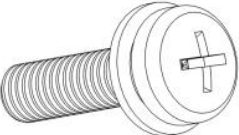
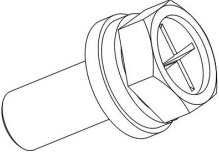
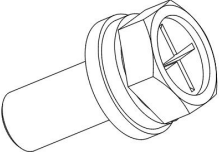
#### Inverter module packing list





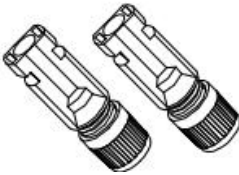

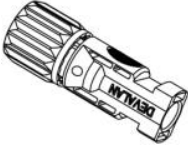
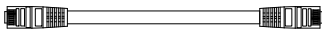
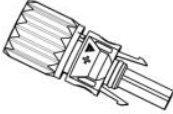
Before installation, carefully check whether the packaging and accessories are intact. Includes the following accessories::

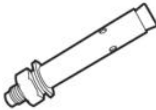
No	Pictures	Description	Quantity
1		Inverter	1pcs
2		Pedestal	1pcs
3		Pedestal cover	2pcs

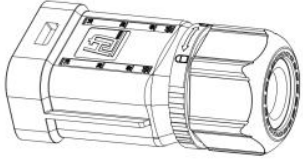

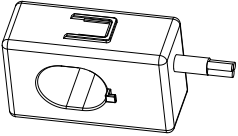
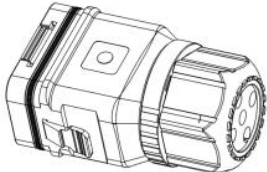

4		Left side cover	1pcs
5		Right side cover	1pcs
6		Hanging rack	2pcs
7		Fixed support rack B	2pcs
8		Side connector	2pcs
9		SEM screw M4*10	6pcs
10		Hexagon screws M5*10	2pcs
11		Hexagon screws M6*14	4pcs
12		PV+ input terminal	2pcs



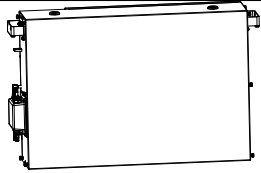
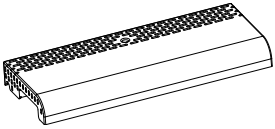
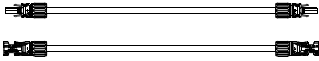

13		PV- input terminal	2pcs
14		Metal terminals secured to PV+ input power cables	2pcs
15		Metal terminals secured to PV- input power cables	2pcs
16		Battery positive terminal + input terminal plastic case	2pcs
17		Parallel connection cable	1pcs
18		Battery negative terminal + input terminal plastic case	2pcs
19		Battery positive + input terminal metal core	1pcs
20		Battery negative - Input terminal metal core	1pcs
21		M6*60 Expansion bolt	4pcs

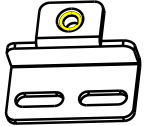
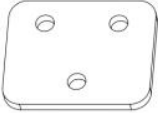
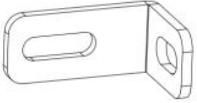
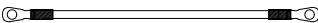
22		AC connector	1pcs
23		Load connector	1pcs
24		Single phase electronic rail mounting meter & current transformer (CT)	1pcs (optional)
25		Current transformer (CT)	1pcs
26		COM 24pin connector	1pcs
27		Manual	1pcs
28		The warranty card	1pcs
29		Quality Certificate	1pcs

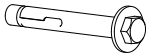
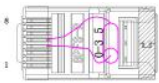

## Battery packing list





No	Pictures	Description	Quantity
1		Battery module	1pcs
2		Side panel	2pcs
3		Battery power connection cable	2pcs
4		Battery signal connection cable	1pcs
5		Fixed support rack A	2pcs
6		Side connector	2pcs
7		Fixed support rack B	2pcs
8		Ground Wire	1pcs
9		Hexagon SEM screws M6*14	4pcs



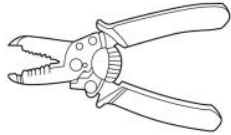

10		SEM screws M4*10	10pcs
11		Expansion bolt M6*60	2pcs
12		Terminal resistance	1pcs
13		Quality Certificate	1pcs

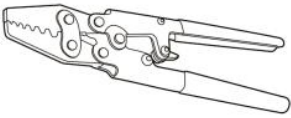
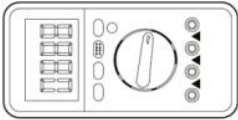
### 3.2. Installation Tools

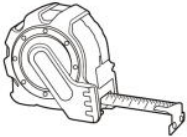
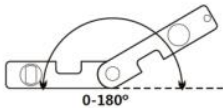
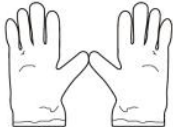
Before installation, prepare the following tools:

NO	Tool	Model	Function
1		Hammer drill Recommend Drill @ Φ8mm	Used to drill holes on the wall.
2		Screwdriver	Remove and install screws and wires
3		Cross screwdriver	Remove and install screws and wires

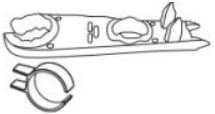
4		Wire stripper	Used to peel cable
5		M6 socket head wrench	Secure the backplane and inverter
6		Crimping Tool	Use to crimp cable on grid side, load side and CT extensive cable
7		Multimeter	Check whether the cable connection is correct, the positive and negative terminals of the battery are correct, and the grounding is reliable
8		Marker	Mark signs
9		Measuring tape	Measure distance
10		Level	Ensure the rear panel is properly installed
11		ESD gloves	Installer wear when installing product

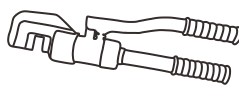
12		Safety goggle	Installer wear when drill holes
13		Mask	Installer wear when drill holes
14		Removal Tool	Remove the output terminal of the battery module
15		sleeve	Install Fixed support rack
16		Crimping tools	Used to crimp OT connector

### 3.3. Installation environment

- ✧ Choose a dry, clean, neat and convenient location for installation.
- ✧ Machine ambient temperature: -10°C~50°C;
- ✧ Relative humidity: 5-95% (non-condensing);
- ✧ The product should be placed in a well-ventilated place;
- ✧ There are no inflammable and explosive objects near the installation position of the product;
- ✧ The product system inverter AC over-voltage level is three;
- ✧ The highest altitude of the installation environment is 4000m.

The installation position of the product should be chosen to avoid direct sunlight, snow position

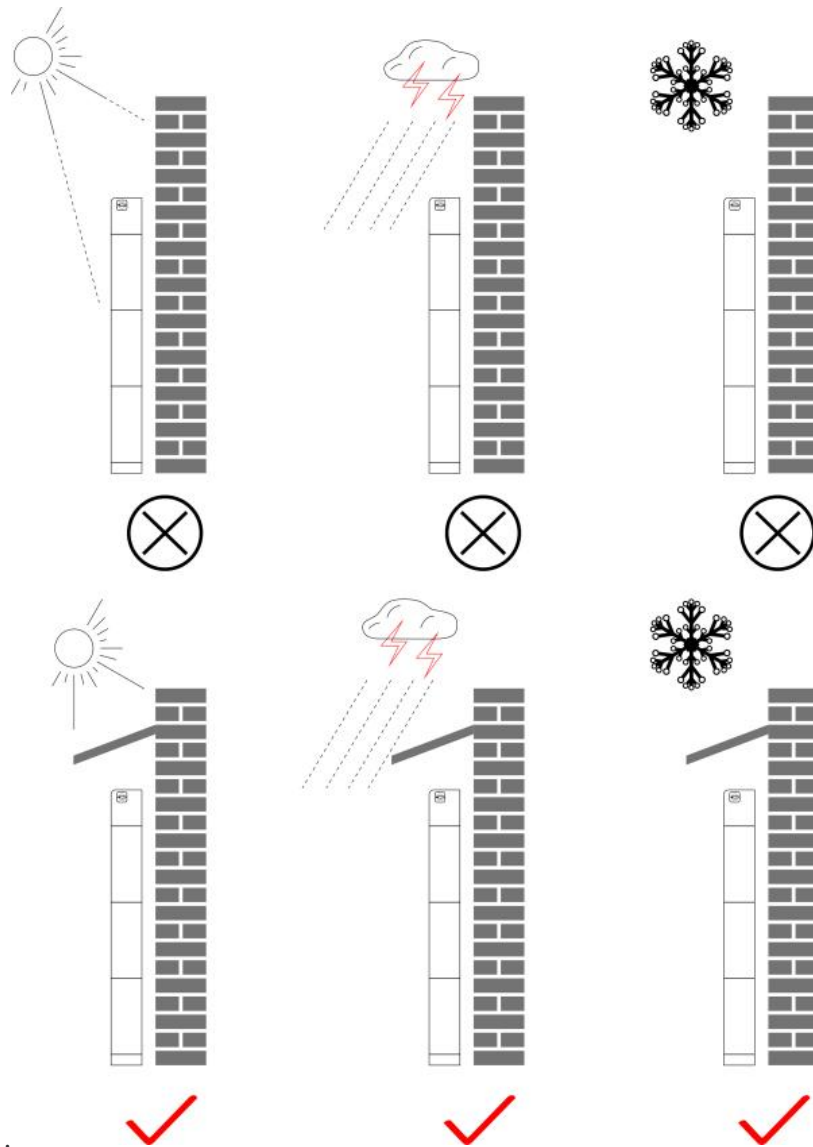

Figure 3.3-1 Installation Environment Diagram

### 3.4. Installation Space

To ensure sufficient space for installation and heat dissipation, reserve sufficient space around the ESI series household energy storage system. The requirements are as follows:

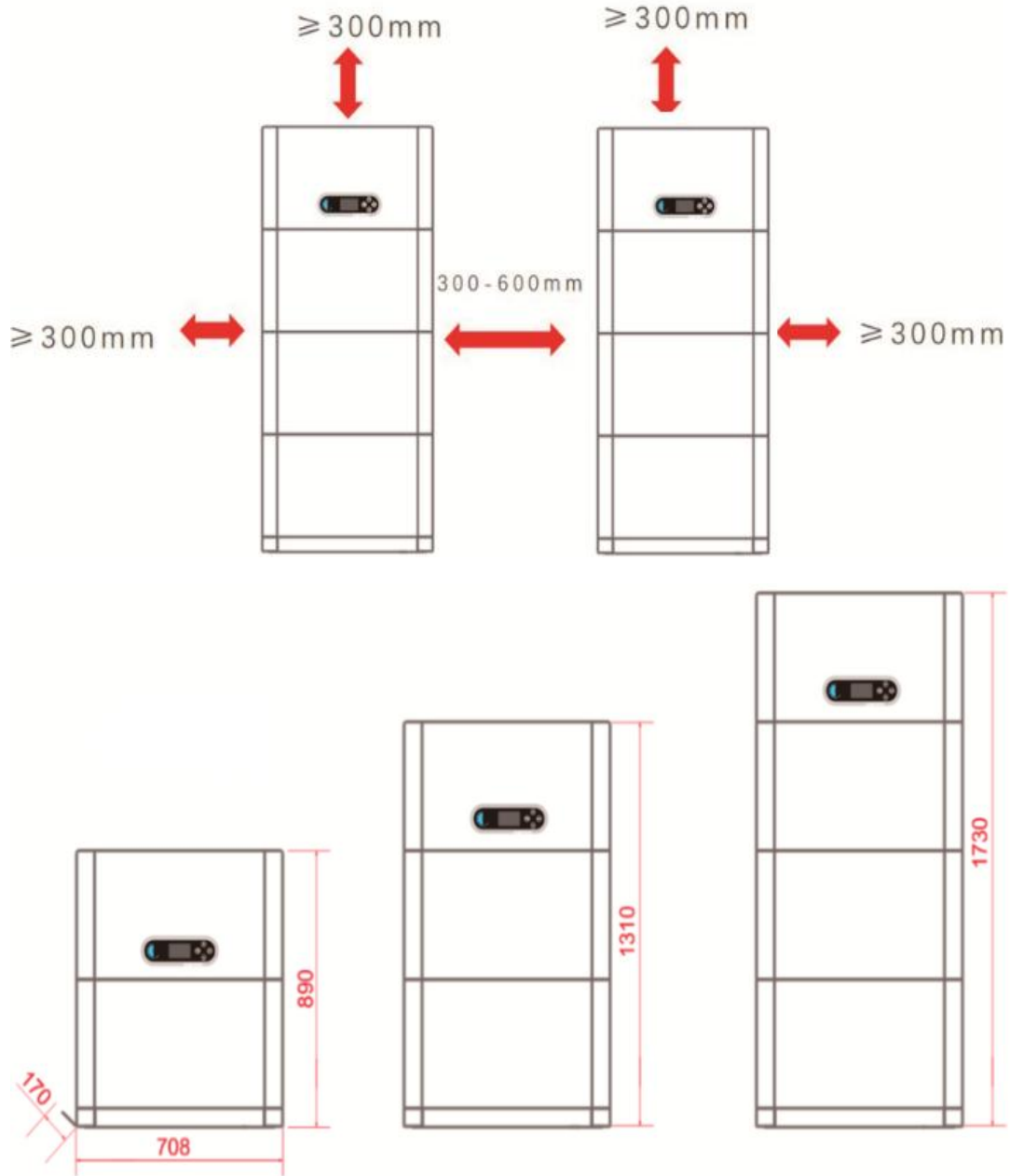

Figure 3.4-1 Installation space diagram



### 3.5. Product Installation

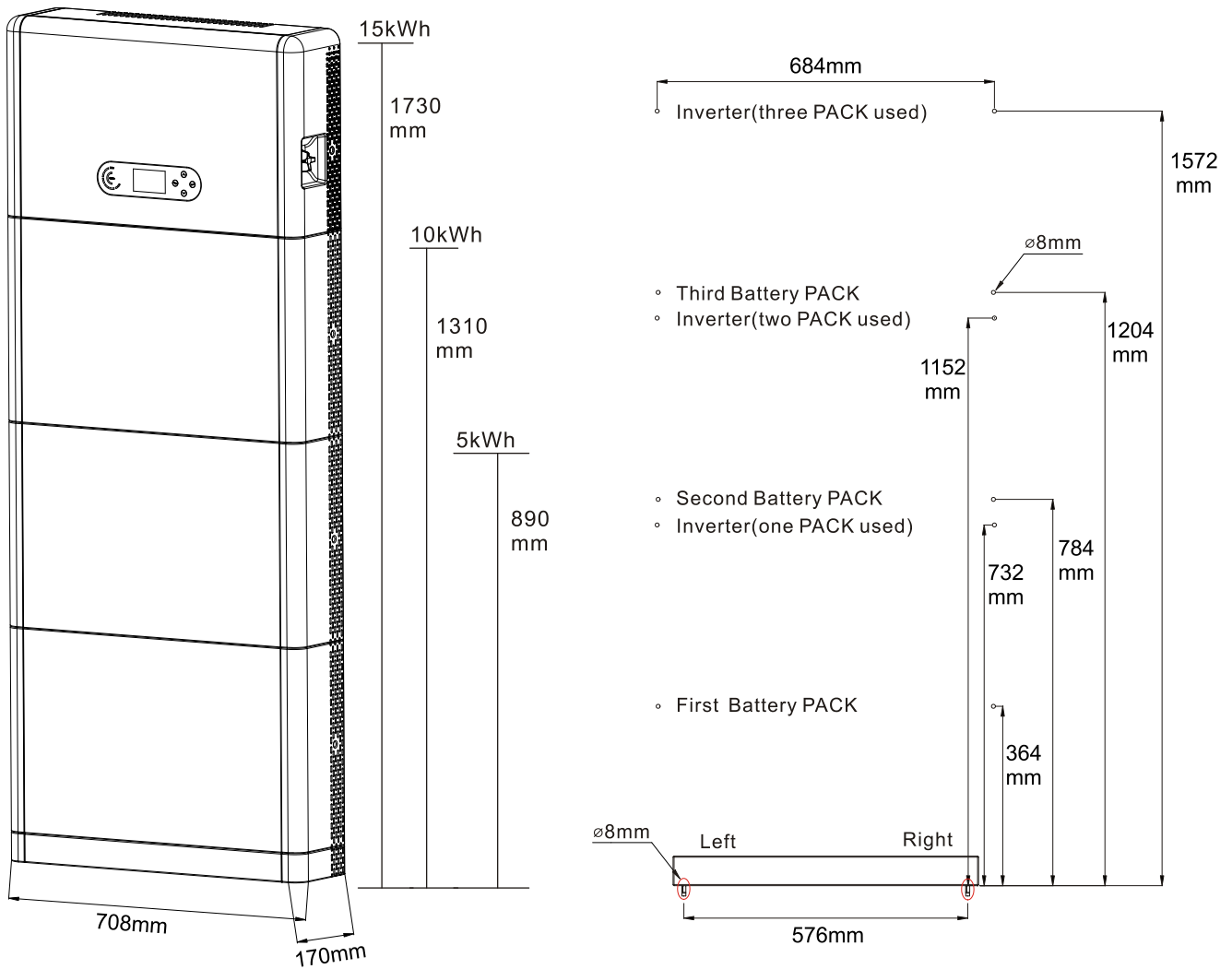

Figure 3.5-1 ESI series installation dimensions diagram

#### Pedestal installation

Procedure:

1) Place the pedestal against a wall and keep it 10 to 25mm away from the wall. Adjust the hole positions using a level, and mark the hole positions using a marker.

2) To install the pedestal, remove the pedestal, drill holes using a hammer drill ( $\varphi$  8mm, depth range 60-65 mm), and tighten expansion screws to ensure that the base is securely installed.

3) Use a marker to mark holes for securing the battery modules and inverters based on the dimensions shown in Figure 3.7-1.

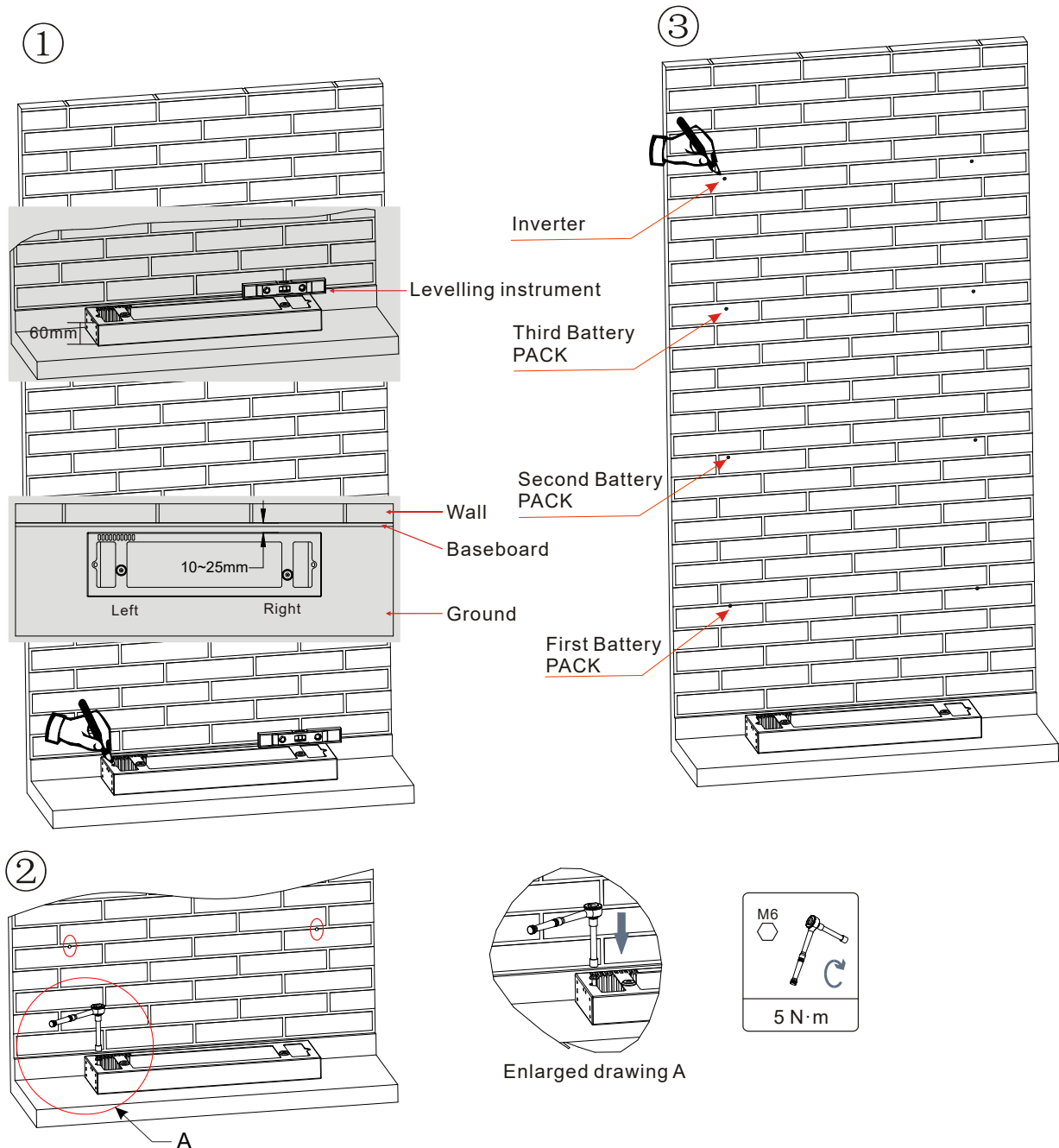

If holes cannot be drilled on the ground, the battery expansion modules must be secured on the wall

Figure 3.5-2 Pedestal installation

Fixed installation between modules :

Procedure :

- 1) Align the first battery module on the floor pedestal.
- 2) Install connectors on both sides and tighten the six screws using a cross screwdriver.
- 3) Install the remaining battery modules and inverters from bottom to top. (Before installing the next module, ensure that the screws on the side connectors of the previous module are firmly installed.)

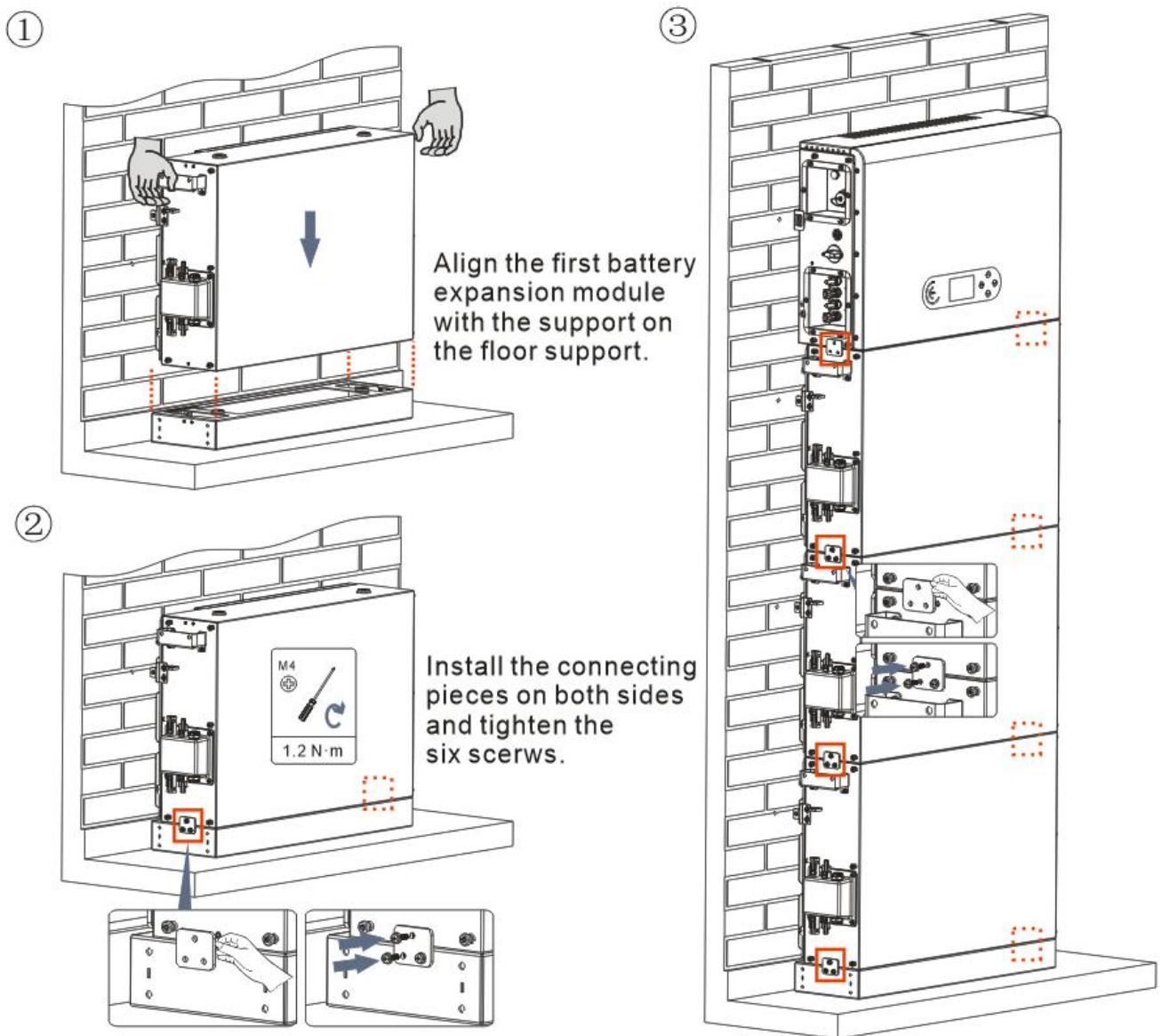

Figure 3.5-3 Battery module and inverter installation diagram

## Support rack installation:

### Procedure:

- 1) Drill holes with a hammer drill ( $\varnothing$  8mm, depth range 60-65 mm). Reposition and drill the holes, if the original one has a large deviation.
- 2) Install the support rack B on the wall, and fastening expansion bolt.
- 3) Adjust the support rack A, make sure the holes are matched between rack A and rack B.
- 4) Connect and fix the rack A and rack B with M6\*16 screws.

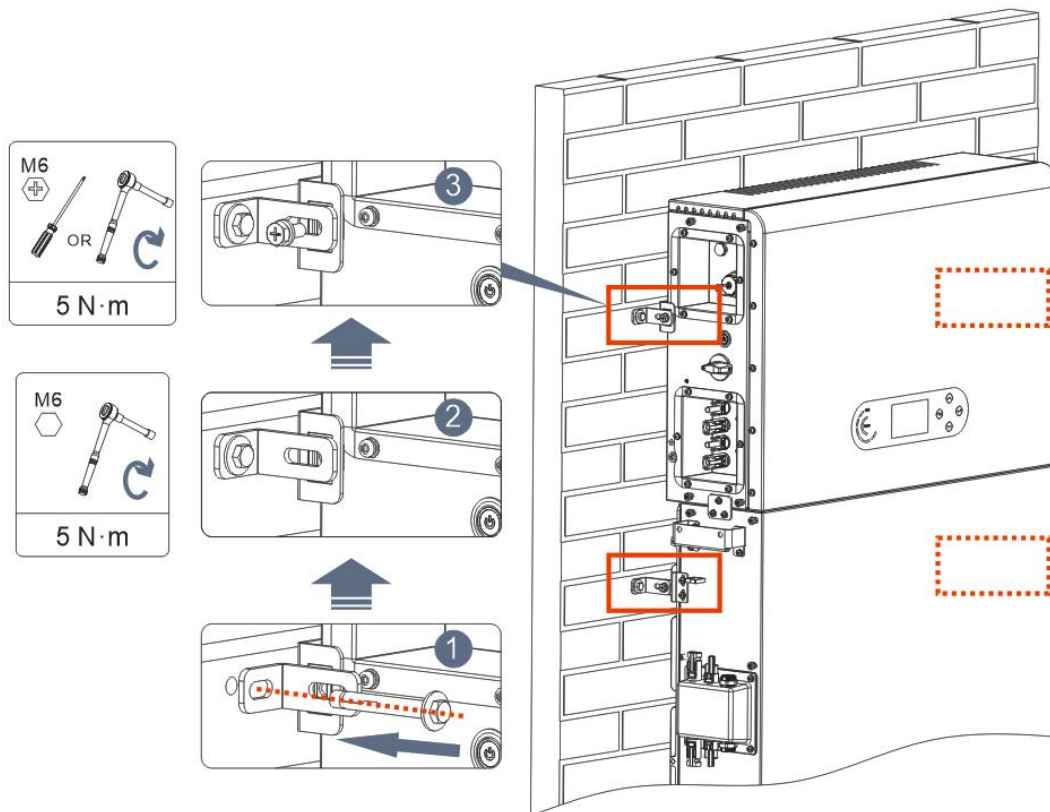



Figure 3.5-4 Schematic diagram of wall fixing installation

# 4. Electrical Connection

## 4.1. Attentions Before Connection

	<p>The voltage in the power conversion circuit of this product is very high. Fatal danger of electric shock or severe burns. All electrical connections of photovoltaic modules, inverters and battery systems must be carried out by qualified personnel.</p>
<p>Attention</p>	<p>Wear rubber gloves and protective clothing (protective glasses and boots) when operating high voltage/current systems such as inverters and battery systems.</p>
	<p>This product is mainly applied to photovoltaic energy storage systems for household use. If not used according to the instructions, the protection provided by the equipment may be damaged.</p>
<p>Attention</p>	

## 4.2. Preparation of Connection Cables

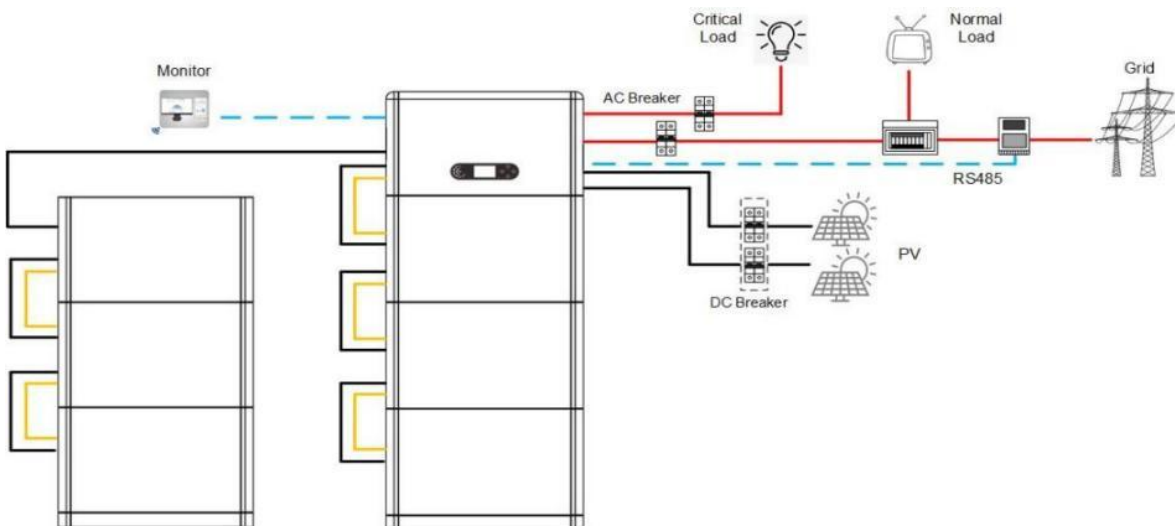

Figure 4.2-1 System connection diagram

Table 4.2-1 Cables prepared by customers

No	Cable	Recommended specifications
1	PV connection cable	UL10269 12AWG
2	AC Grid connection cable	UL10269 8AWG
3	EPS connection cable	UL10269 10AWG
4	Grounding cable	UL10269 8AWG

### 4.3. Electrical Connection for Internal System

#### 4.3.1. Internal protection grounding cable connection

Connect the grounding cables of the battery module and inverter as shown in Figure 4.3.1-1.

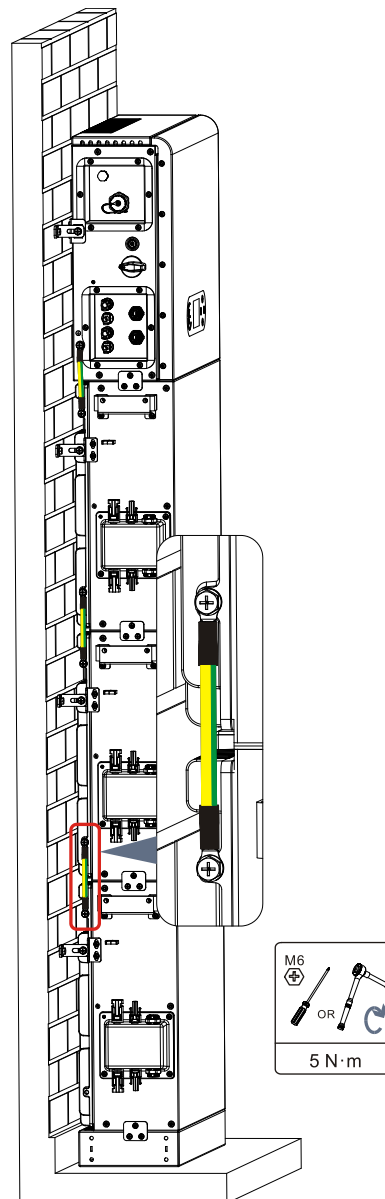

Figure 4.3.1-1 Internal grounding cable connection

### 4.3.2. Power cables connection

As shown in Figure 4.3.2-1, connect the power ports (BAT+,BAT-) of the inverter to the cascading positive and negative power cables (B+,B-) of the battery module. Connect the remaining battery modules from top to bottom, and secure the cables with cable ties. Ensure that the cables are securely connected.

#### Precautions during installation:

- If the system capacity is greater than 15kWh, the batteries are connected to the inverter's battery input interface in two independent groups.

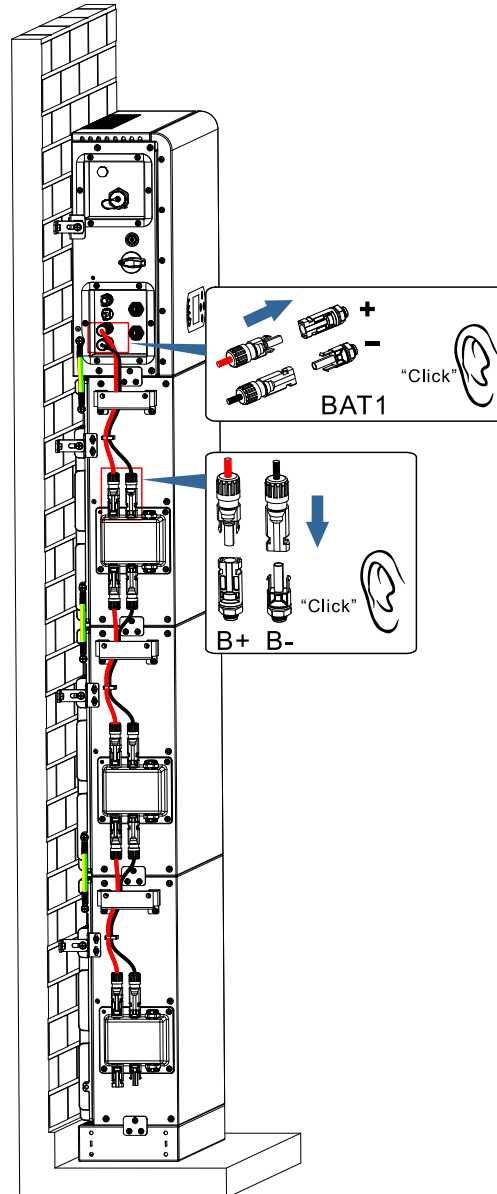

Figure 4.3.2-1 Connection of battery internal DC terminal

### 4.3.3. Internal communication cable connection

Connect the communication terminals of the inverter and battery module from top to bottom according to 4.3.3-1 in the following figure, and secure them with cable ties. In addition, install a matching resistor on the communication interface of the last battery module in the system.



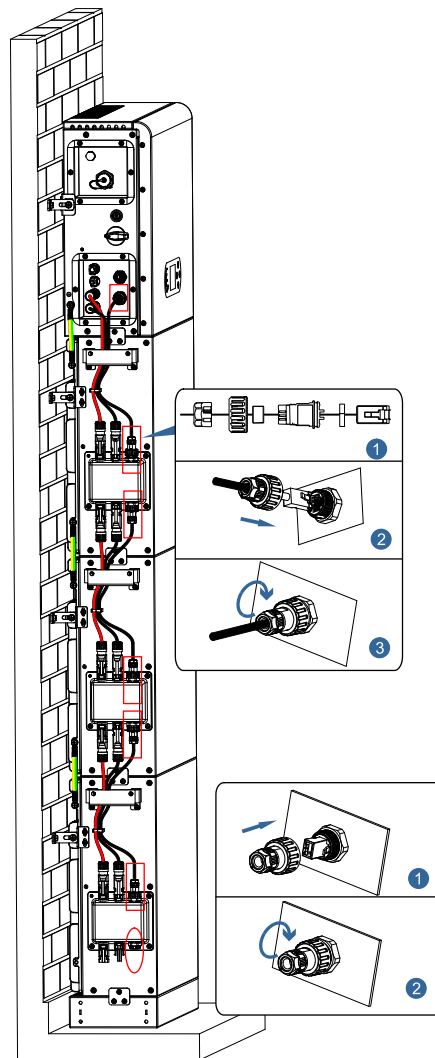

Figure 4.3.3-1 Internal signal cable connection

#### 4.3.4. Data collector connection

Connect the standard WIFI/4G collector in the inverter package according to 4.3.4-1 in the following figure.

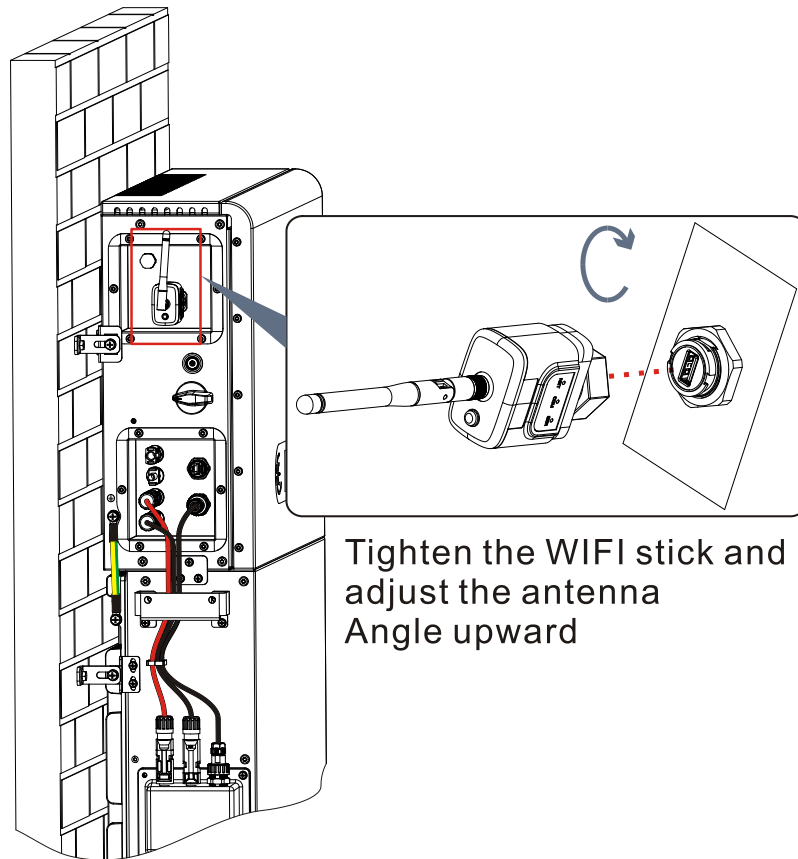

Figure 4.3.4-1 WIFI/4G connection

## 4.4. External Electrical Connection

### 4.4.1. External ground Connection of the PGND cable

#### Procedure 1 Crimp OT terminals

#### Precautions:

- When stripping the cable, do not scratch the core of the cable.
- The conductor crimping plate of an OT terminal is pressed to form a cavity that completely covers the conductor core and tightly binds the OT terminal.
- The crimping line can be covered with heat shrink tubing or insulation tape.

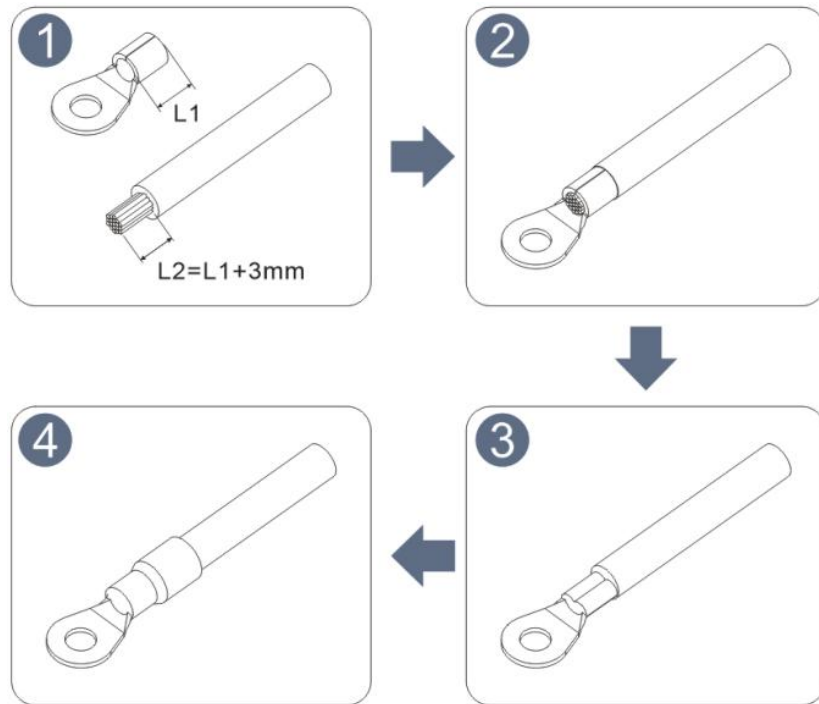

Figure 4.4.1-1 Diagram of Crimping OT terminals

Procedure 2 The OT terminal is crimped properly, and the ground cable is connected to the position shown in the following figure.

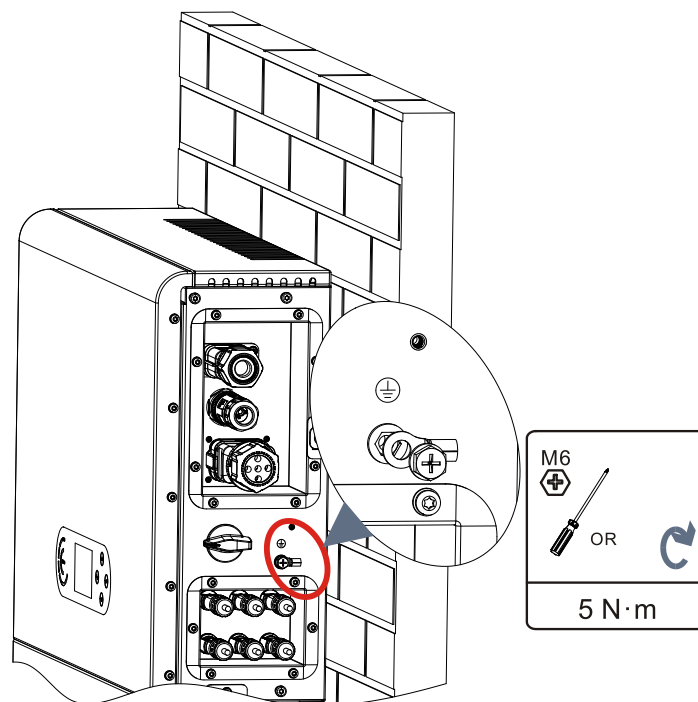

Figure 4.4.4-2 Connect the grounding wire

### 4.4.2. PV module connection

Recommended DC input cable specifications

CAS (mm <sup>2</sup> )		External cable diameter(mm <sup>2</sup> )
Range	Recommended value	
4.0~6.0	4.0	4.5~7.8

#### Connection Procedure:

**Step 1:** Prepare PV positive and negative power cables;

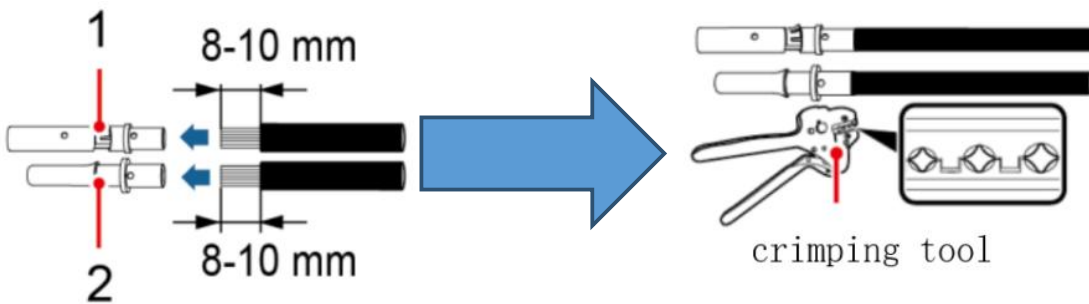

1. Positive connector 2. Negative connector

Figure 4.4.2-1 Prepare PV positive and negative power cable

**Step 2:** Insert the crimped photovoltaic positive and negative power cable into the corresponding photovoltaic connector.

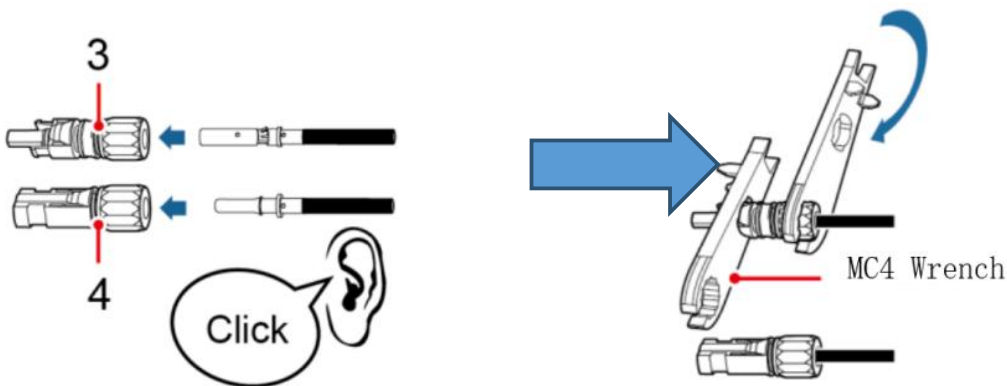

3. Positive connector 4. Negative connector

Figure 4.4.2-2 Prepare PV positive and negative connectors

**Step 3 :** Ensure that the DC voltage of each PV string is less than 600V and the polarity of PV cables are correct. Insert the positive and negative connectors into the corresponding PV region of the ESI series inverter until a click is heard. As the figure 4.4.2-3 showing.

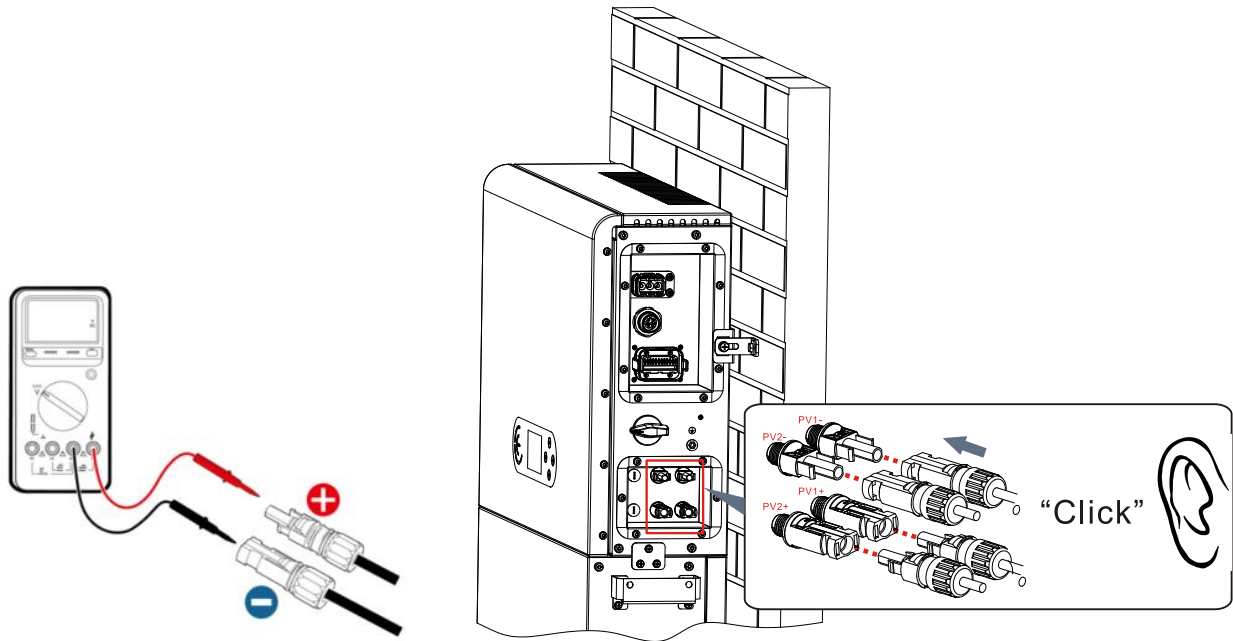



Figure 4.4.2-3 Connect PV connector

	<p>Ensure that the DC switch is turned off before removing the PV positive and negative connectors.</p>
<p><b>Caution</b></p>	

**Follow-up Step**

Disconnect the PV connector using an MC4 wrench, as shown in Figure 4-6.

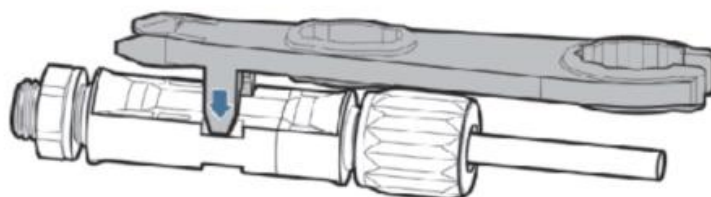

Figure 4.4.2-4 Disconnect PV connectors

### 4.4.3. Grid connection

#### Install AC wiring terminals

Take out AC wiring terminals from the carton of the inverter, strip and install cables according to the cable specifications listed in Table 4.2-1

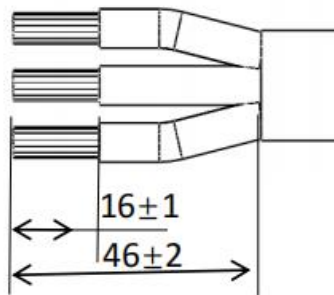
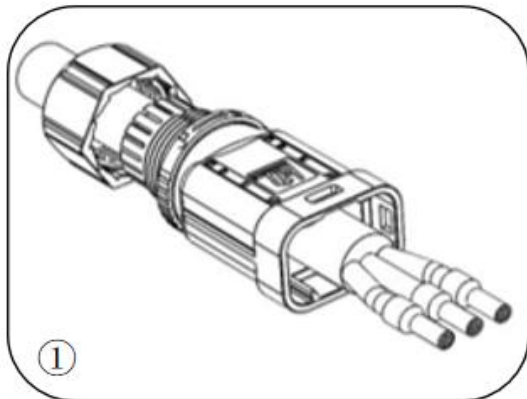
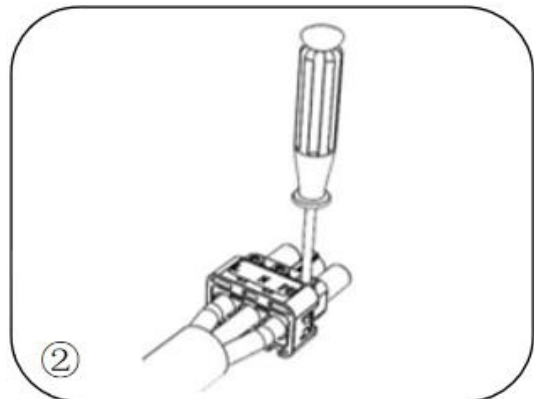

Figure 4.4.3.-1 Wire stripping size

#### Installation Step



① After riveting the peeling wire to the insulation terminal, thread it into the lock wire nut and the main body.



② Insert the cable into the rubber core according to the wire sequence, make the insulation terminal flush with the surface of the rubber core, and press the screw torque  $2.0 \pm 0.1 \text{ n.m}$

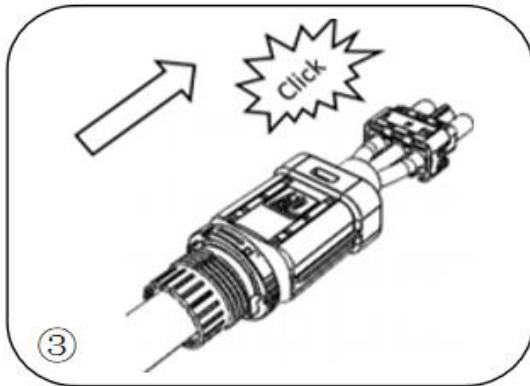

The body is inserted into the core and a click is heard

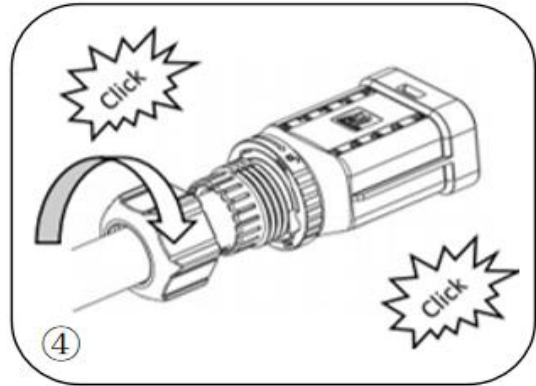

Tighten the nut with an open wrench and make a "click" sound

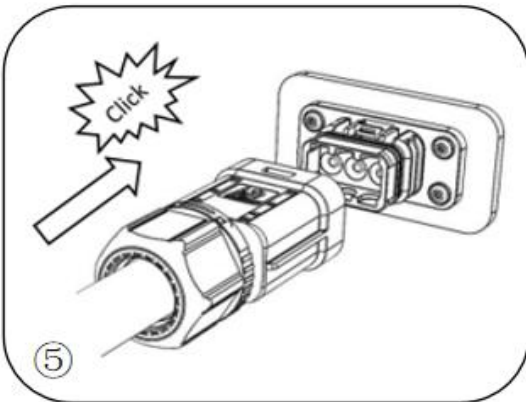

Insert the female end of the wire into the male end and hear a "click" sound

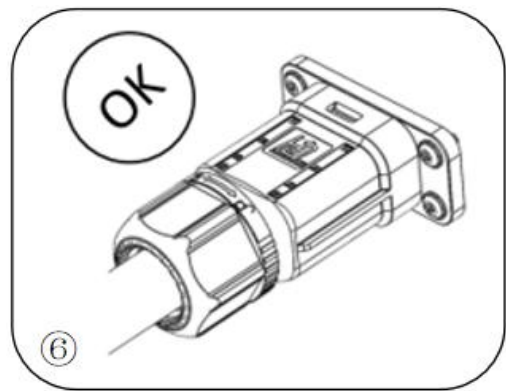

Installation complete

Figure 4.4.3-2 Installation Procedure Diagram

### Removal Step

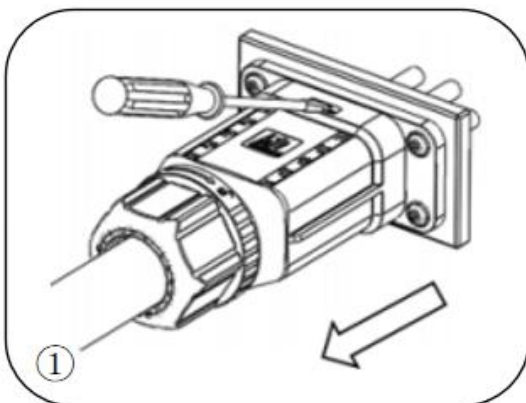

Use a screwdriver to point at the unlocking position, hold the cable driver, and pull it back to separate the male and female

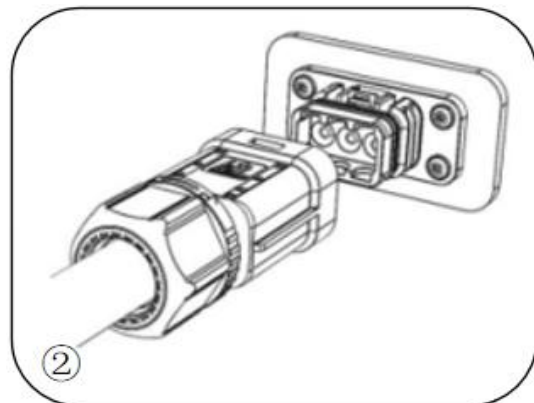

The female connector is separated from the board connector

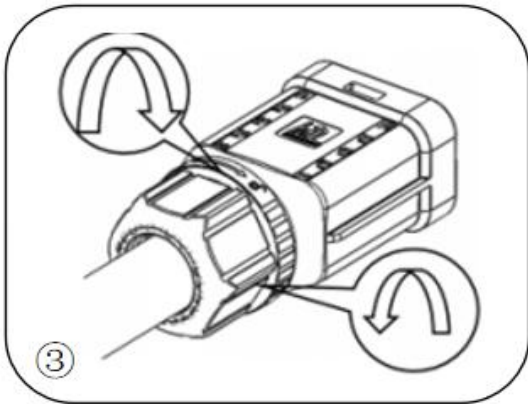

Hold the unlocking buckle with one hand and rotate it in the direction indicated, while rotate the nut in the opposite direction with the other hand

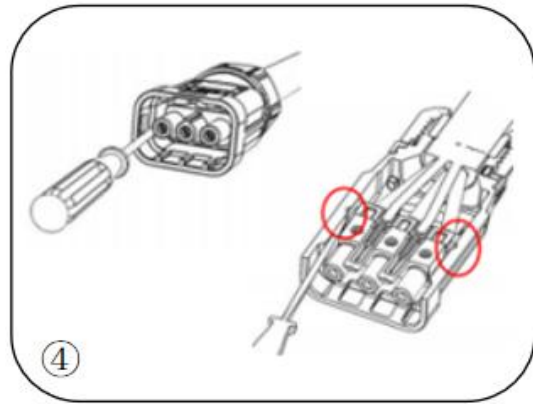

Remove the red circles on both sides using a screwdriver

Figure 4.4.3-3 Removal procedure

Connect the AC wiring terminals to the corresponding AC Grid ports, as shown in the following figure.

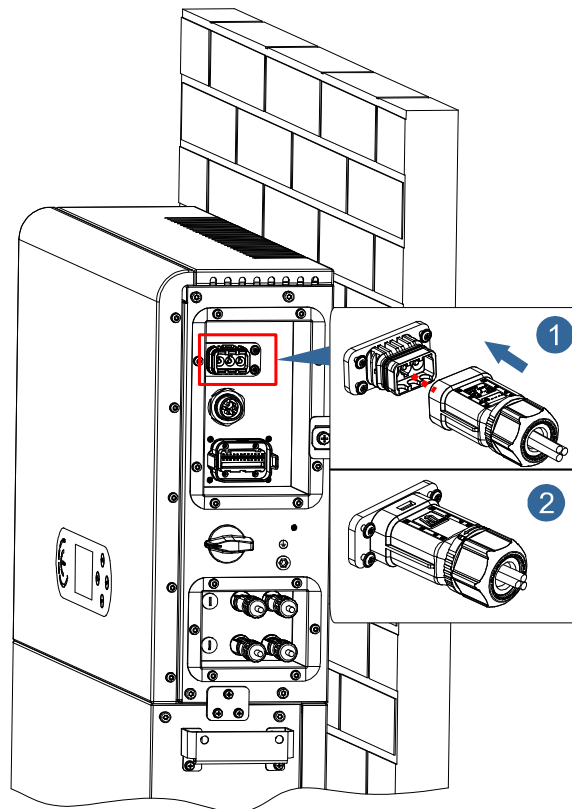

Figure 4.4.3-4 Grid connection



### 4.4.4. EPS connection

According to the cable specifications given in Table 4.4.1, peel the cable according to the following figure 4.4.4-1. Then install the EPS connector according to 4.4.4-2. Finally, insert the installed EPS connector into the corresponding position of the inverter according to Figure 4.4.4-3.

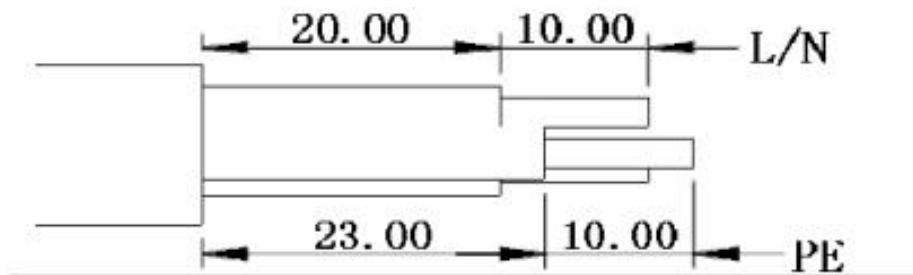
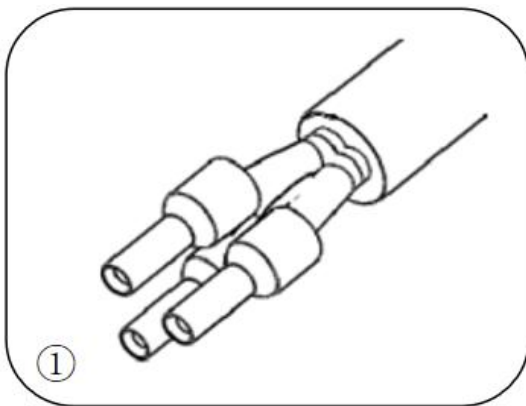
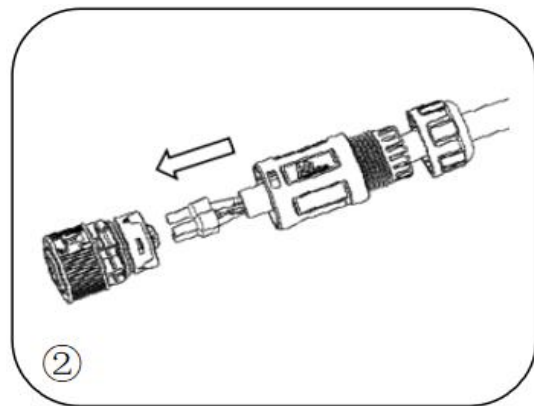

Figure 4.4.4-1 Stripping diagram

#### Install procedure



Crimp terminal



Insert the cable into the butt terminal

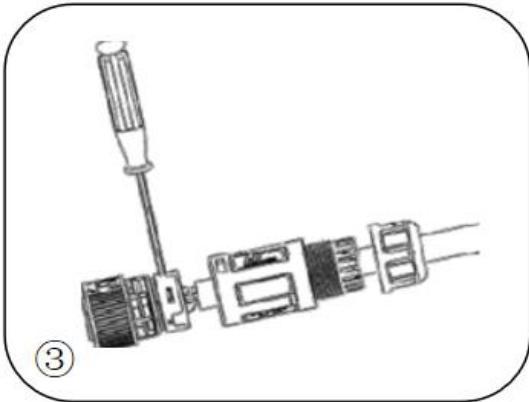

③ Crimp the wire with an inner hexagon screwdriver with a screw torque of  $1.2 \pm 0.1 \text{ n.m}$

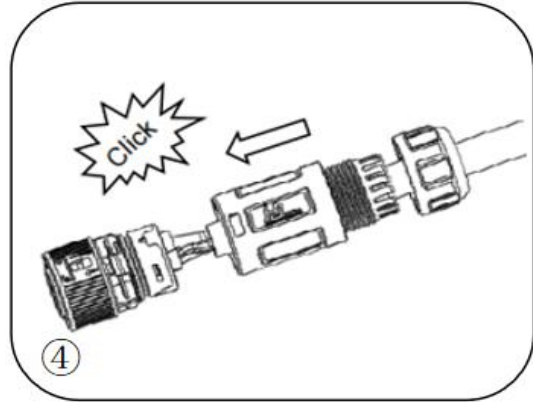

④ Insert the subject into the corresponding clasp and hear a "click"

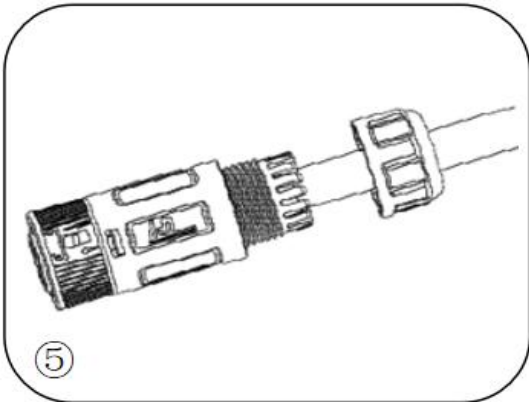

⑤ Screw locking nut into main body, torque  $2.5 \pm 0.5 \text{ n.m}$

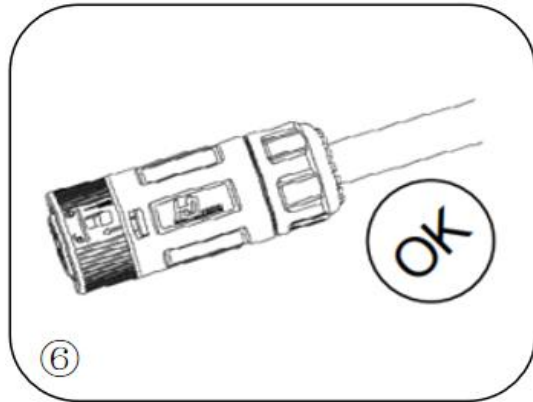

⑥ Installation complete

Figure 4.4.4-2 EPS Connector installation

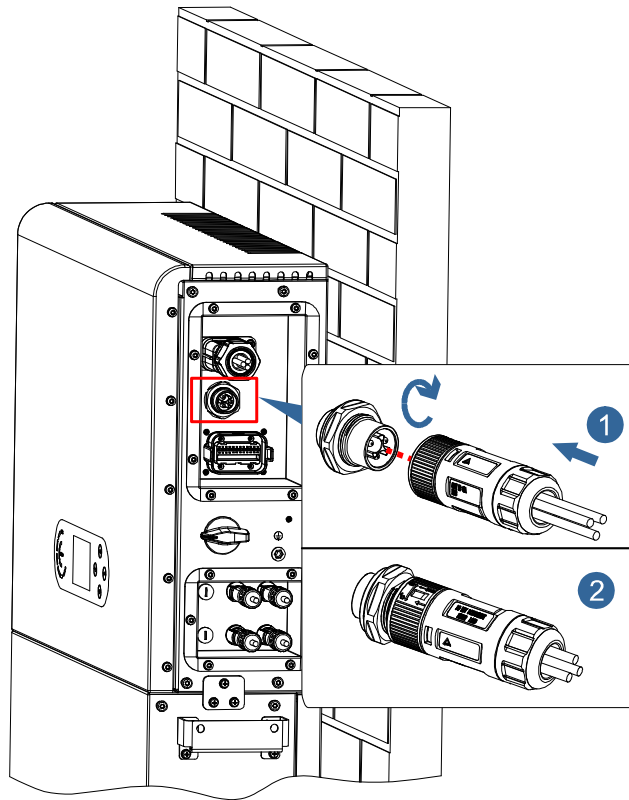

Figure 4.4.4-2 EPS connection

### 4.4.5. COM-Multi function communication connection

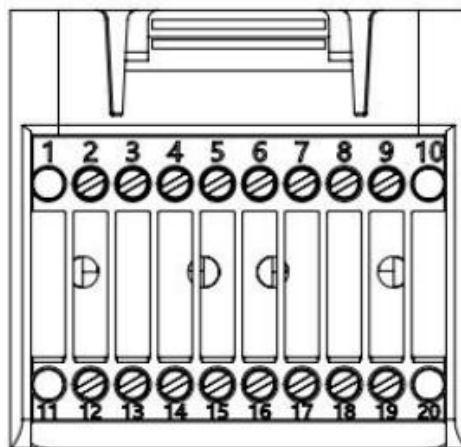

Figure 4.4.5-1 COM port diagram

Table 4.4.5-1 Port description

PIN	Definition	Function	Comment
-----	------------	----------	---------

1	N/A	N/A	
2	UC-A	RS485 differential signal -A	Inverter monitoring 485 signal
3	UC-B	RS485 differential signal -B	
4	EN+	RS485 differential signal +	Battery 485 signal
5	EN-	RS485 differential signal -	
6	MET-A	RS485 differential signal -A	Smart meter 485 signal
7	MET-B	RS485 differential signal -B	
8	CANH	CAN high data	Battery CAN communication signal
9	CANL	CAN low data	
10	N/A	N/A	
11	N/A	N/A	
12	GND	Logic interface signal	(DRMS) Logical interfaces uses for below standard Australia (AS4777) , Europe General (50549) , German (4105)
13	D1/5		
14	D4/8		
15	D2/6		
16	D0		
17	D3/7		
18	CT+	Current transformer output positive terminal	Current transformer communication signal
19	CT-	Current transformer output negative pole	
20	N/A	N/A	

Link Port

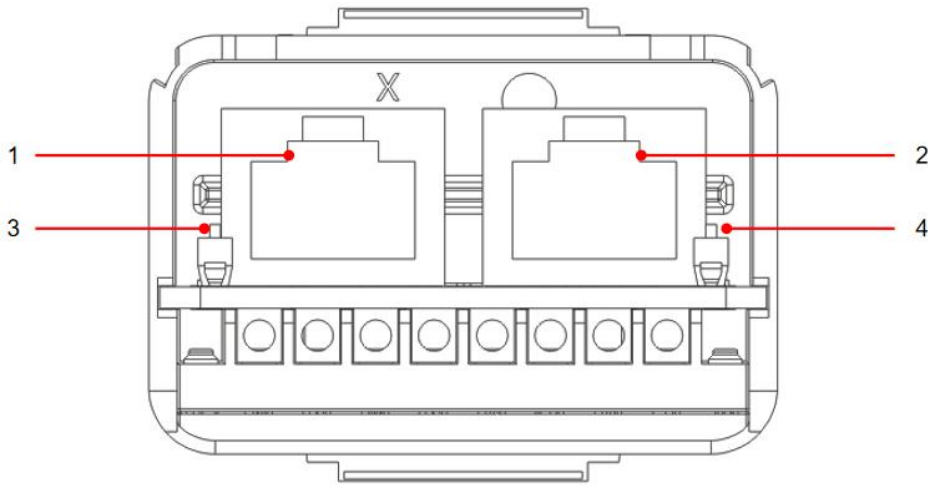

Figure 4.4.5-2 Link Port diagram

Table 4.4.5-2 Link Port description

Icon	Define	Function	Comment
1	Link Port 1	Parallel signal output	Parallel signal port (RJ45)
2	Link Port 0	Parallel signal input	
3	Link Port 1 dip switch	Match resistance on and off	The dial switch has 0 (dial up) and 1 (dial down). 1 means on and 0 means off
4	Link Port 0 dip switch		

The wire stripping is divided into 2 to 9 holes and 12 to 19 holes. The wire stripping size is defined according to the cable connection position

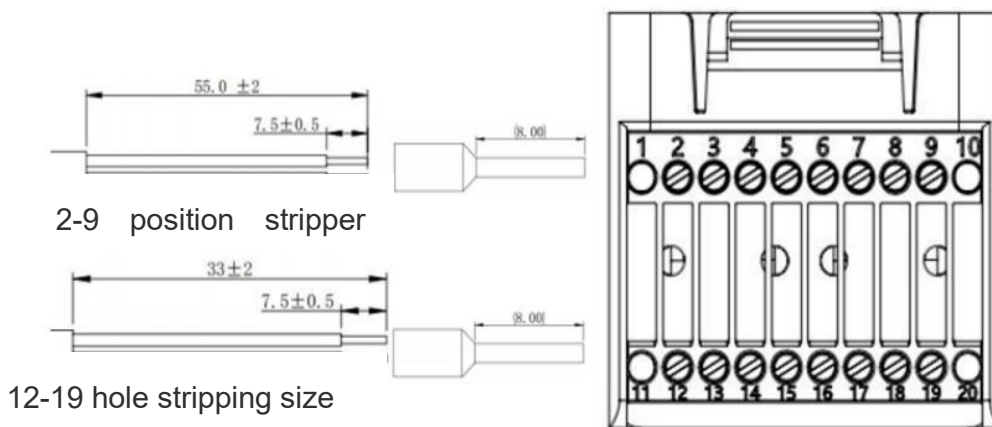

Figure 4.4.5-2 Schematic diagram of wire stripping size

**1. RS485 (Wired monitoring or inverter cascade monitoring)**

Refer to the figure shown below, connect the RS485+ and RS485- of the inverter to the TX+ and TX- of the RS485 → USB adapter, and connect the COM port of the adapter to the computer. (NOTE : The length of the RS485 communication cable should be less than 1000 m)

Connect pins as shown(2pin and 3pin)

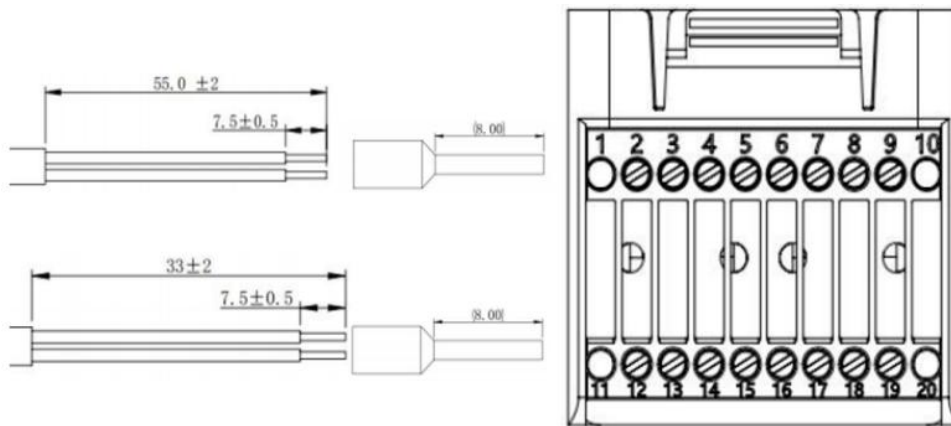

Figure 4.4.5-3 RS 485 wiring diagram

RS485 wires are connected in parallel between inverters, (NOTE : When multiple inverters are connected via RS485 wires, set communication address to differentiate the inverters , please refer to this manual<6.3.1System setting→8.Communication Addr>)

**2. Logic interface**

The logic interface pin definitions and circuit connections are as follows:

Logic interface pin are defined according to different standard requirements

(a) Logic interface for AS/NZS 4777.2:2020, also known as inverter demand response modes (DRMs).

The inverter will detect and initiate a response to all supported demand response commands within 2 s. The inverter will continue to respond while the mode remains asserted.

Table 4-6 Function description of the DRMs terminal

Pin NO.	Function
---------	----------

12	GND
13	D1/5
14	D4/8
15	D2/6
16	D0
17	D3/7

(b) Logic interface for EN50549-1:2019, is in order to cease active power output within five seconds following an instruction being received at the input interface. The inverter can be connected to a RRCR (Radio Ripple Control Receiver) in order to dynamically limit the output power of all the inverters in the installation.

Fig.4-12 Inverter – RRCR Connection

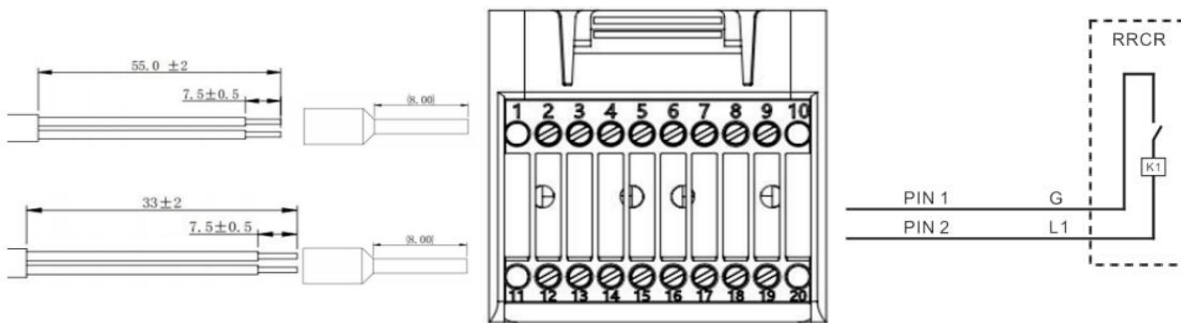

Figure 4.4.5-3 DRMs wiring diagram

Table 4-9 Function description of the terminal

COM Pin NO.	Pin name	Description	Connected to (RRCR)
PIN 13(PIN2)	L1	Relay contact 1 input	K1 - Relay 1 output
PIN 12(PIN1)	G	GND	K1 - Relay 1 output

Table 4-10 The inverter is preconfigured to the following RRCR power levels,close is 1, open is 0

L1	Active Power	Power drop rate	Cos(φ)
1	0%	<5 seconds	1
0	100%	/	1

3.Meter/CT

PIN5 and PIN6 of COM are used for meter communication, the electricity meter is shown in the fig.①, PIN5 and PIN6 correspond to 7, 8 respectively on the electricity meter, as shown in fig.③.

The connection mode is shown in fig.②. The 1/2 and 3/4 on the electricity meter are connected to voltage signals L and N respectively. And the current needs to be connected through the current transformer, 5, 6 correspond to the current transformer.

NOTE:The direction of the current transformer is shown in fig.④.

Fig. Meter

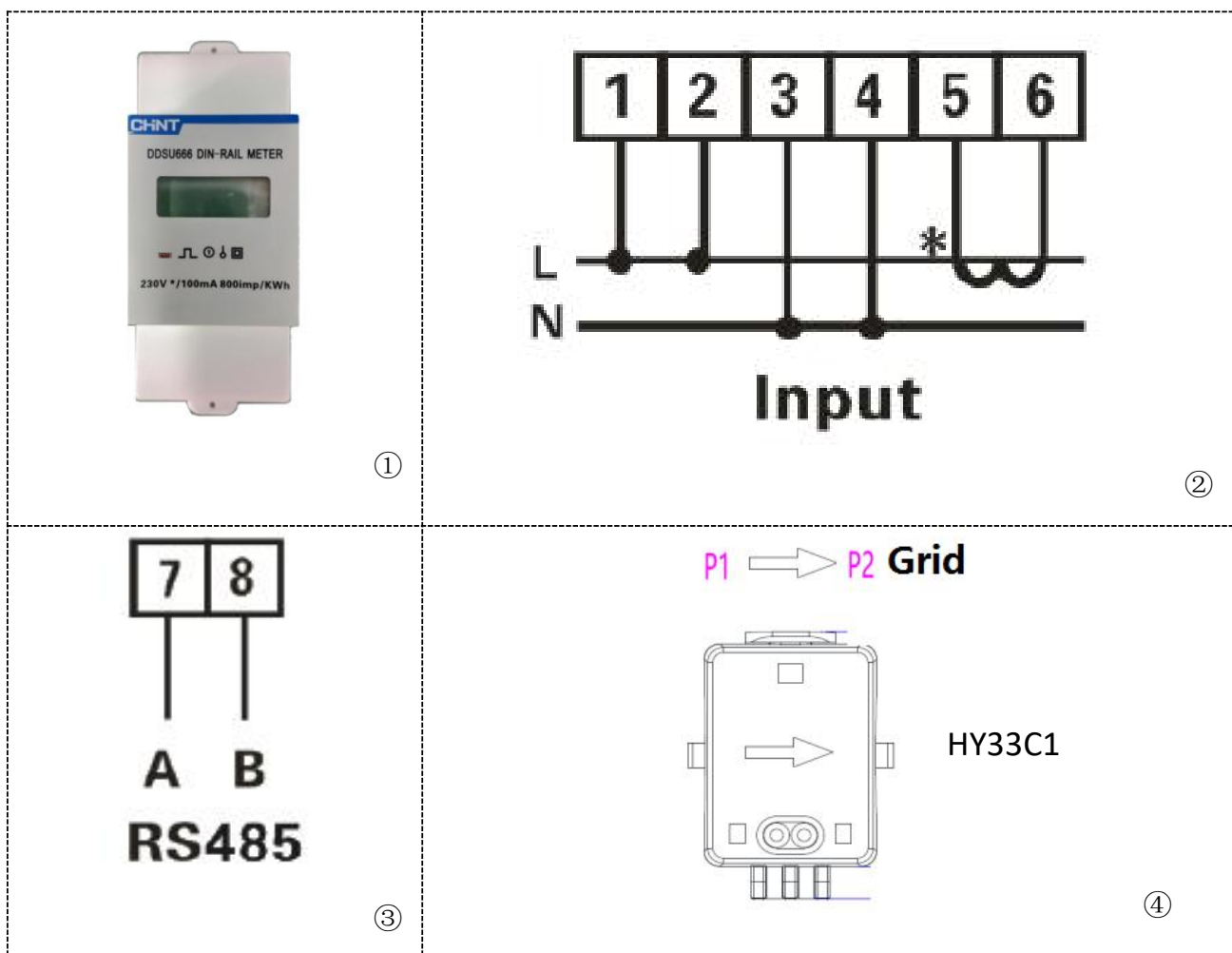

If you need to use the CT alone, attach the CT to PIN18 and PIN19.

There are two ways to get grid current information :

Plan A:CT(default)

Plan B:Meter +CT

If you need to use the meter +CT scheme, please contact SOFARSOLAR staff to purchase the appropriate meter and CT.



## COM Installation procedure for connecting cables

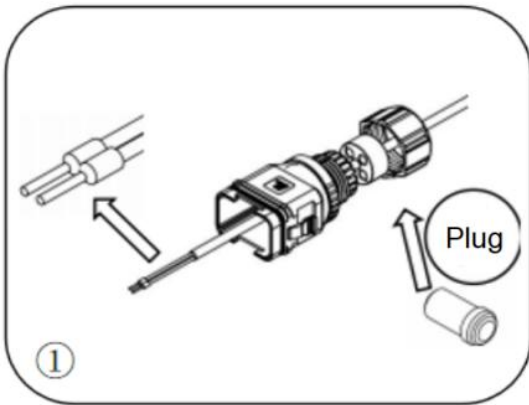

①

Remove the plug from the plug and thread the terminal in the order shown

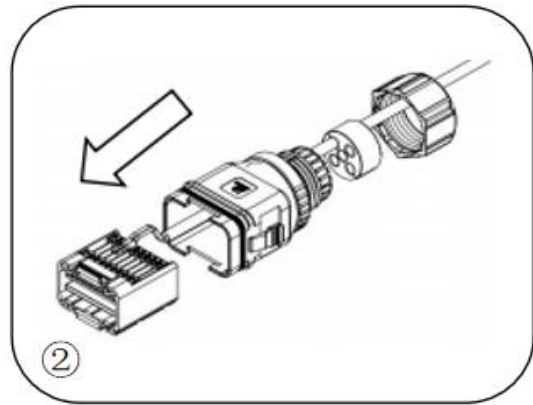

②

Insert the wire into the corresponding terminal

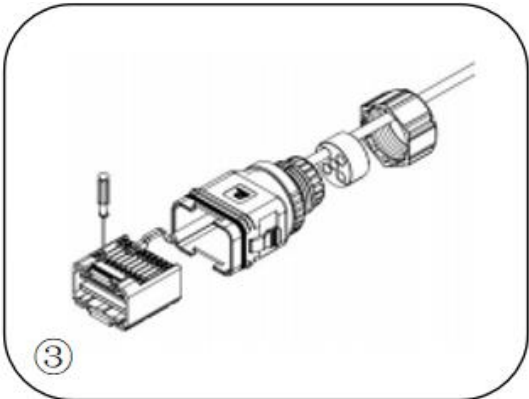

③

Crimp the wire with a flat-head screwdriver with a torque of  $1.2 \pm 0.1 \text{ n.m}$

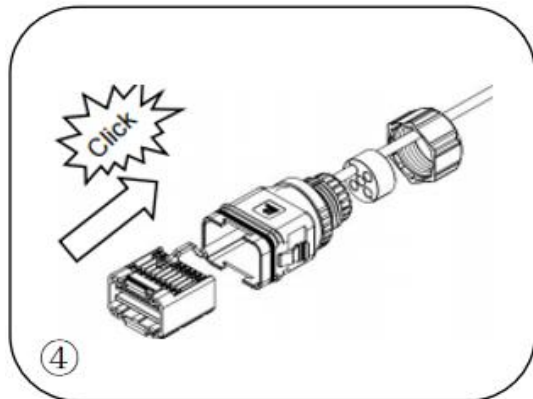

④

Line core, rubber core area can not appear riding line phenomenon, rubber core into the main body with a "click" sound

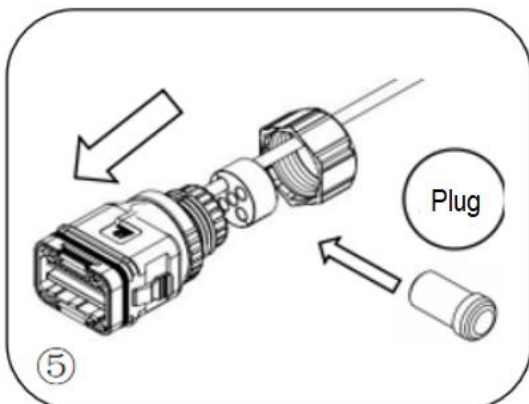

⑤

Insert the plug into the body and plug the unwired hole

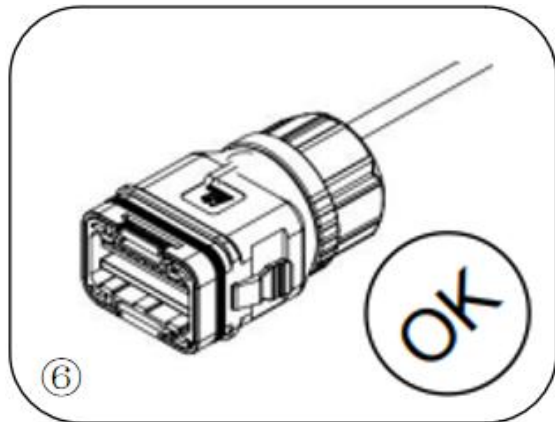

⑥

Screw the lock nut into the main body, torque  $2.5 \pm 0.1 \text{ n.m}$ , complete installation

----- procedure for con-----

Insert the stripped COM connector into the corresponding port of the inverter, as shown in the following figure.

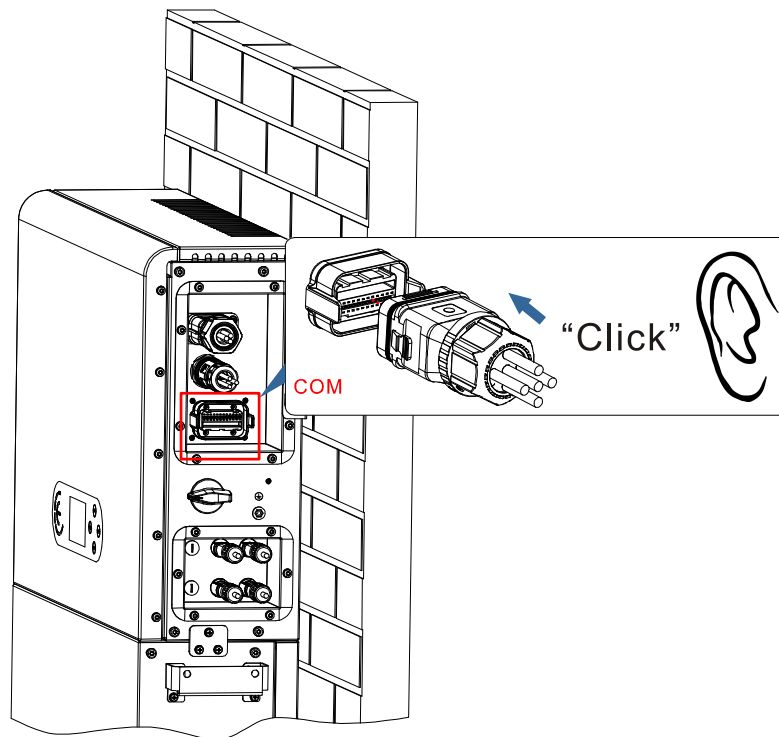

Figure 4.4.5-4 COM connection

#### 4.4.6. Smart Meter /CT

Refer to the COM interface description in table 4.1, the RS485A and RS485B of the electricity meter should be connected to pin6 and pin7 of the COM port of the inverter.

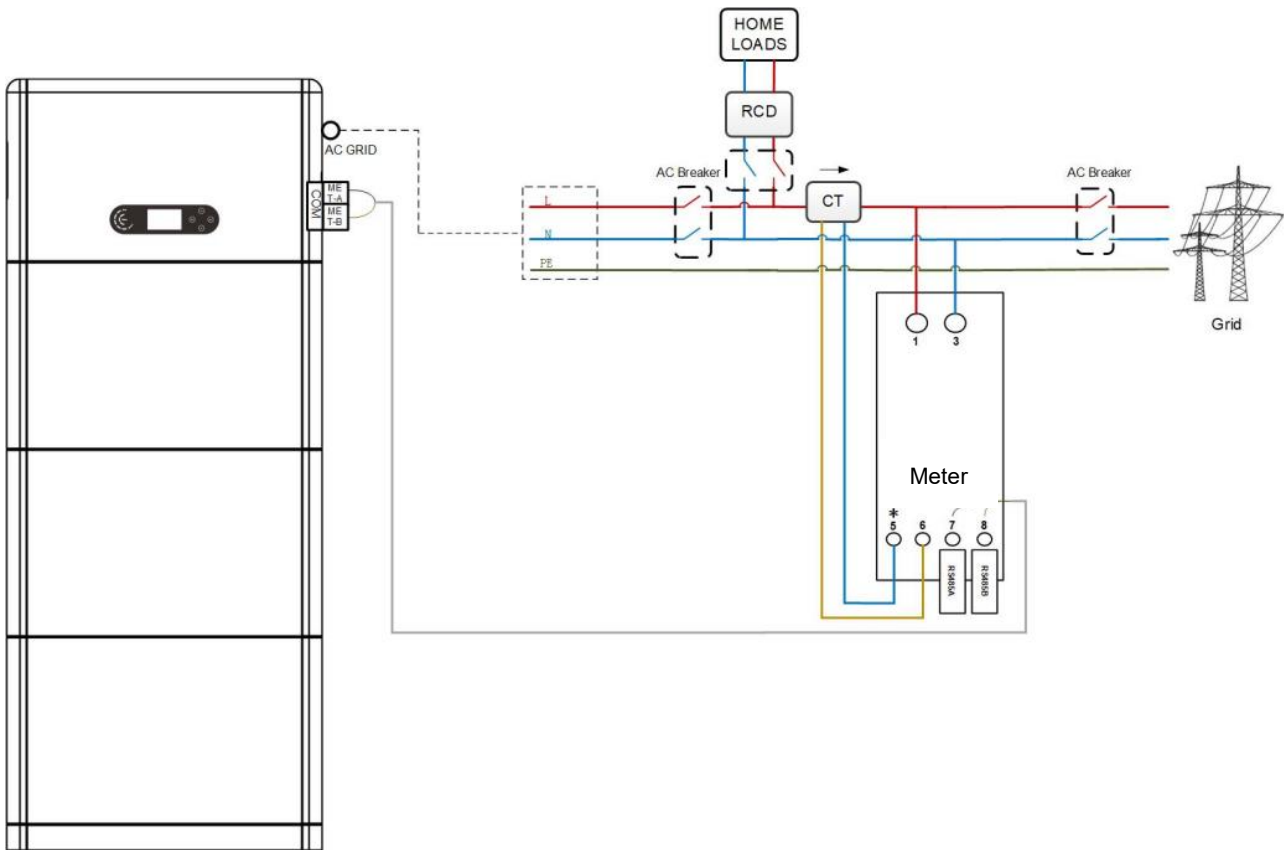

Figure 4.4.6-1 Smart meter/CT connection diagram

### 4.5. Install the cover

After electrical connections are complete and cable connections are correct and reliable, install the external protective cover and secure it using screws.

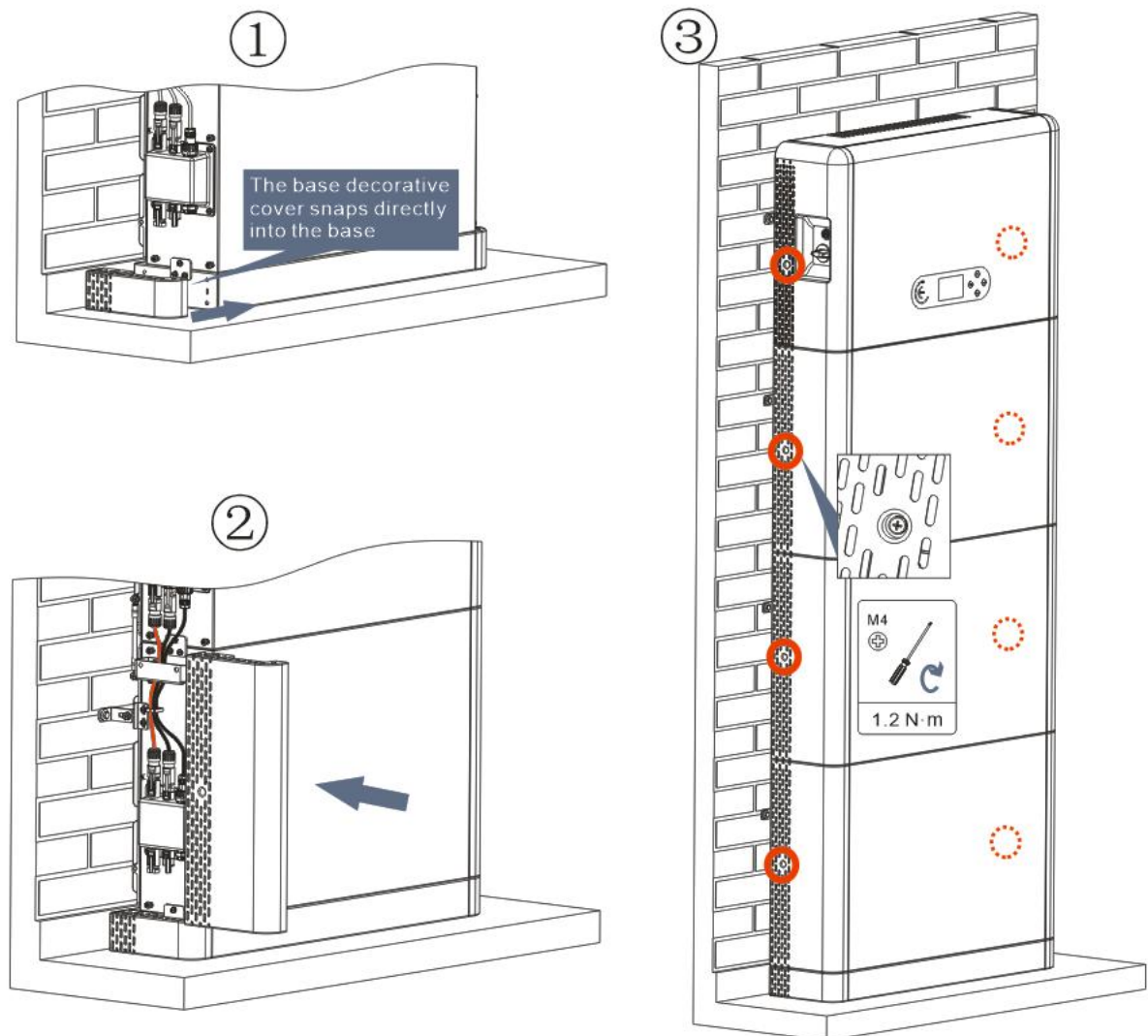

Figure 4.5-1 4.5.Install the cover

## 4.6. Parallel system

Refer to figure 4.6-1 below and connect the system in parallel according to the success of the master and slave (up to 6 units). The dip switch inside the COM 24PIN connector of the last system inverter should be moved to the position of 1.

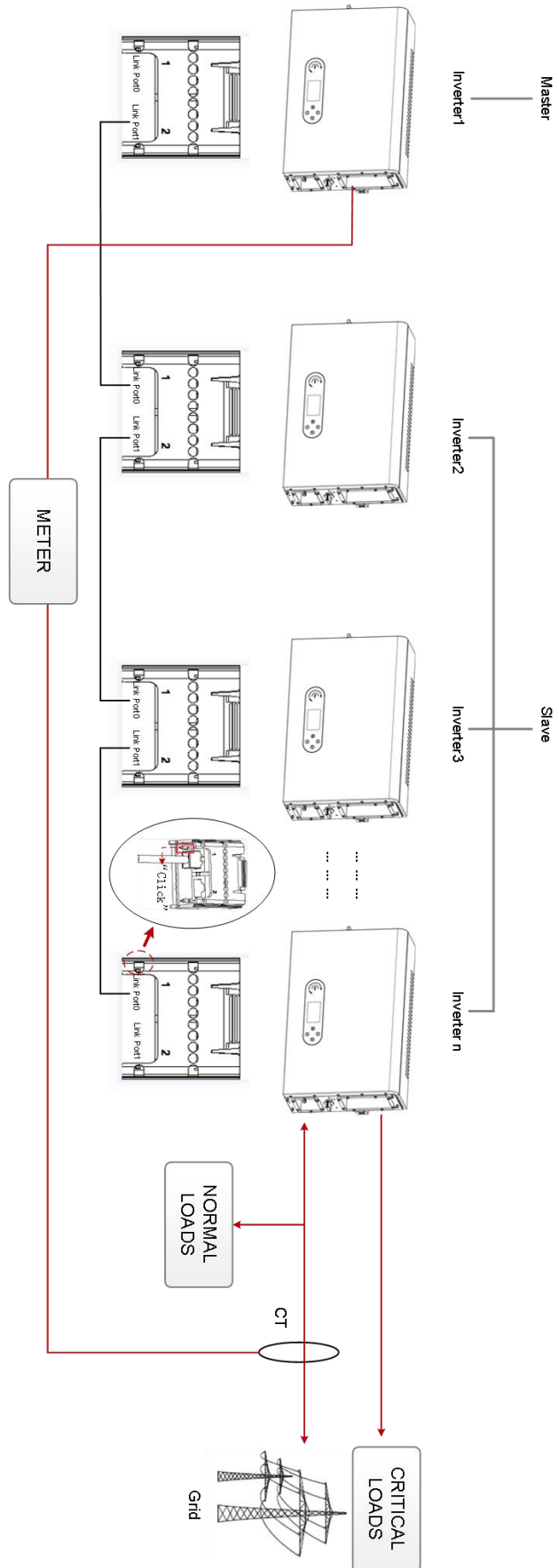

Figure 4.6-1 System parallel diagram

### 4.7. System Electrical Topology

SOFARSOLAR has already integrated RCMU (residual current monitoring unit) inside inverter, If an external RCD is required, a type-A RCD with rated residual current of 100mA or higher is suggested.

ESI series household energy storage system is mainly composed of PV modules, BTS 5K battery modules, inverters, AC switches, load and distribution units, smart meters /CT, and power grid.

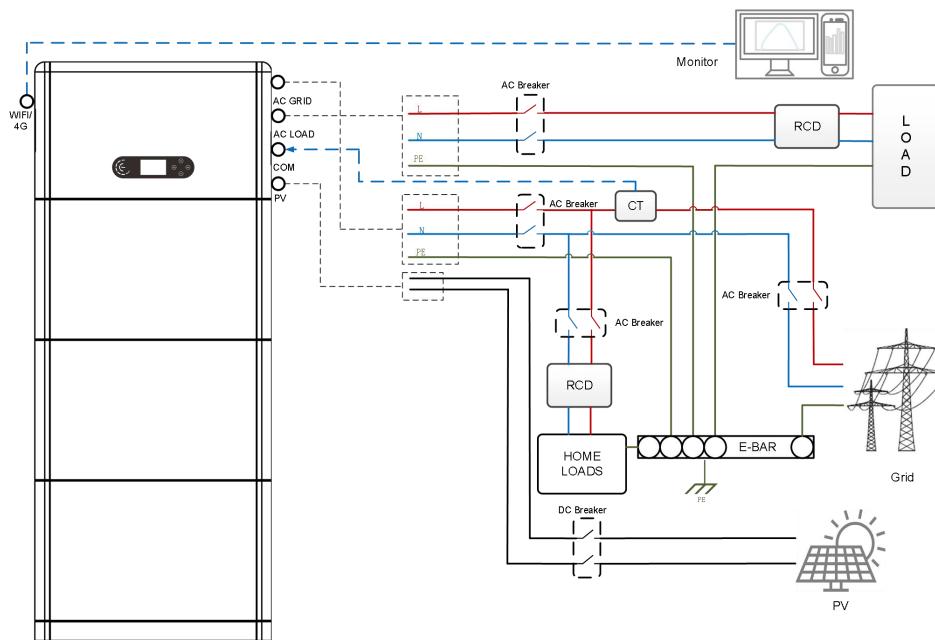

Figure 4.7-1 System Electrical Topology (General)

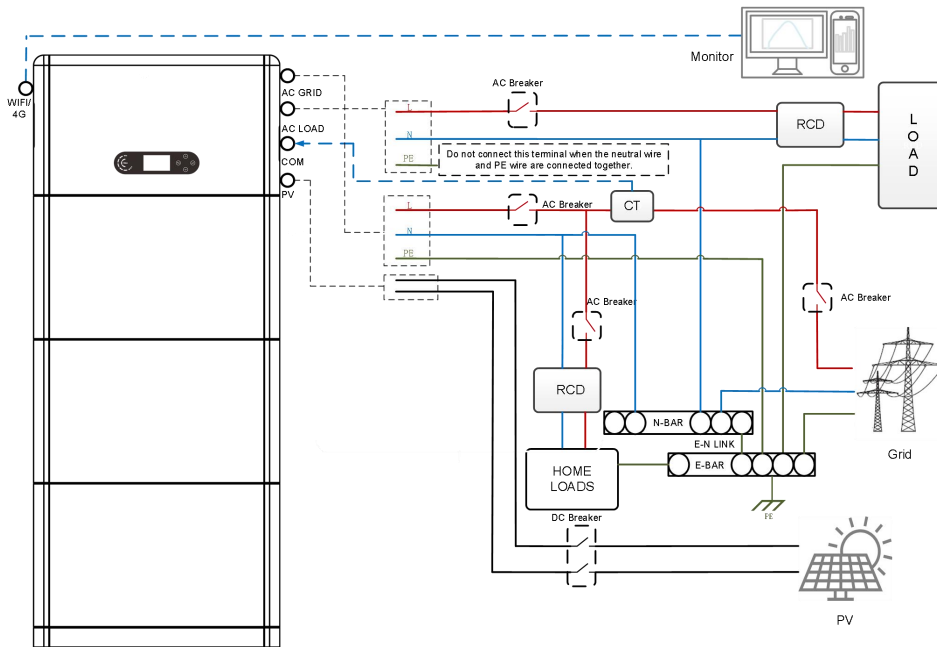

Figure 4.7-1 System Electrical Topology (Australian version)

Note: If you need to select a cable connection mode based on the power distribution system, set the connection mode on the LCD. In advanced Settings, select off grid grounding to set the connection mode. If the connection mode is improperly set, grounding errors may occur

## 5. Commissioning

### 5.1. Checking Before System Starting

Please double check the following items before running

1. The product should be completely fixed on the pedestal bracket, and the connection with the wall should be tight and firm.
2. The PV+/PV- line is firmly connected, the polarity is correct, and the voltage is in line with the accessible range.
3. BAT+/BAT cables are firmly connected, the polarity is correct, and the voltage meets the accessible range.
4. Grid/load cable connections are firm/correct.
5. The inverter power grid port is correctly connected to the power grid and the AC circuit breaker is disconnected.
6. The inverter load port is correctly connected to the emergency load, and the circuit breaker is disconnected.

### 5.2. Electrify for the First Time (Important)

Important: Please follow the steps below to turn on the inverter.

1. Ensure that the phase connected to the inverter of the product does not generate power.
2. Switch the DC switch ON the PV side of the product to ON.
3. Switch the DC switch ON the battery side of the product to ON, and press the battery black start button to activate the battery.
4. Turn on the AC circuit breaker between the inverter power grid port and the power grid.



5. Turn on the AC circuit breaker between the inverter load port and the emergency load.
6. Press the system power button, and the inverter starts running. The system status indicator is blue..

When the inverter is running, set the following parameters.

Table 6- 1 Setting parameter

Parameter	Comment
1.Menu language selection	Default English
2.Set and confirm system time	If the collector or mobile APP is connected to the monitoring system, the time has been calibrated to the local time
*3.Safety parameter import	<p>USB import: you need to find the safety parameters file (named by the corresponding safety country) on the website, download to the USB, import</p> <p>Bluetooth import: Connect the Bluetooth mode of the product through the SOFARSOLAR Cloud data App, and import the safety file(All countries and regions operate in the same way)</p>
4.Setting the input channel	The default order: BAT1, BAT2, PV1, PV2)
5. Setup is complete	

Table 6-2 List of regulated countries

Code	Country	Code	Country
000	000 Germany VDE4105	018	000 EU EN50438
	001 Germany BDEW		001 EU EN50549
	002 Germany VDE0126	019	000 IEC EN61727

001	000	Italia CEI-021 Internal	020	000	Korea
	001	Italia CEI-016 Italia	021	000	Sweden
	002	Italia CEI-021 External	022	000	Europe General
	003	Italia CEI0-21 In Areti	024	000	Cyprus
002	000	Australia	025	000	India
	001	Australia AU-WA	026	000	Philippines
	002	Australia AU-SA	027	000	New Zealand
	003	Australia AU-VIC	028	000	Brazil
	004	Australia AU-QLD		001	Brazil LV
	005	Australia AU-VAR		002	Brazil 230
	006	Australia AUSGRID		003	Brazil 254
	007	Australia Horizon	029	000	Slovakia VSD
003	000	Spain RD1699		001	Slovakia SSE
004	000	Turkey		002	Slovakia ZSD
005	000	Denmark	033	000	Ukraine
	001	Denmark TR322	035	000	Mexico LV
006	000	Greece Continent	038	000	Wide-Range-60Hz
	001	Greece island	039	000	Ireland EN50438
007	000	Netherland	040	000	Thailand PEA
008	000	Belgium		001	Thailand MEA
009	000	UK G59/G99	042	000	LV-Range-50Hz
	001	UK G83/G98	044	000	South Africa
010	000	China	046	000	Dubai DEWG
	001	China Taiwan		001	Dubai DEWG MV
011	000	France	107	000	Croatia
	001	France FAR Arrete23	108	000	Lithuania
012	000	Poland			

	<p>It's very important to make sure that you have selected the correct country code according to requirements of local authority.</p>
<p><b>Caution</b></p>	<p>Please consult qualified electrical engineer or personnel from electrical safety authorities about this.</p> <p>SHENZHEN SOFARSOLAR Co., Ltd. is not responsible for any consequences arising out of incorrect country code selection.</p>

Tebal 6-3 Default values for other Settings

Item	Default status
Energy Storage Mode	Self-use Mode
EPS Mode	Disable
Anti Reflux	Disable
IV Curve Scan	Disable
Logic Interface	Disable

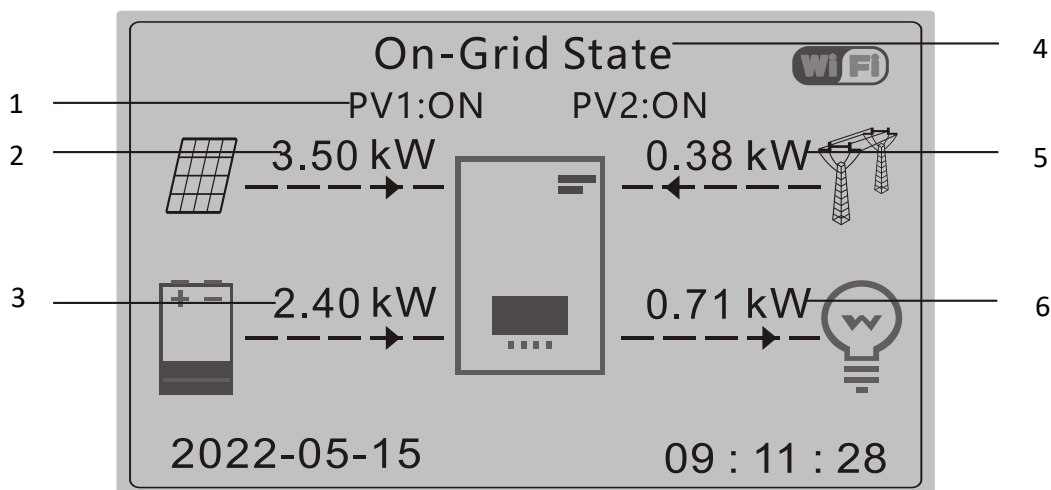

### 5.3. Menu



- 1 Circulates current PV and battery statue      2 PV Power      3 Battery Power
- 4 Display current inverter status                      5 Grid Power      6 Loads Power

Figure 6-1 Main interface

In the main interface, press “” button to enter Grid/Battery/PV parameter page.

Main interface		Grid Output Information
		Grid(V).. .....***.*V
		AC Power .....**.*kW
		Frequency.....**.*Hz
		Battery Information
		Batt.....***.*V
		Batt Curr.....**.*A
		Batt Power.....**.*kW
		Batt Temp.....*°C
		Batt SOC.....**%
		Batt Cycles.....*T
		PV Information
		PV1 Voltage .....***.*V
		PV1 Current.....**.*A
		PV1 Power.....**.*kW
		PV2 Voltage .....***.*V
		PV2 Current.....**.*A
		PV2 Power.....**.*kW
		Inverter Temp.....*°C

In the main interface, press “” button to enter main menu. The main menu has the following six options.

Main Interface



1.System Settings
2.Advanced Settings
3.Energy Statistic
4.System Information
5.Event List
6.Software Update
7.Battery Real-time Information

### 5.3.1. System Setting

1. System Setting



1.Language Setting
2.System Time
3.Safety Param.
4.Energy Storage Mode
5.Auto Test
6.Input channel Configuration
7.EPS Mode
8.Communication Addr.

#### 1. Language Settings

Used to set the menu display language.

1.Language Settings



1. 中文
2.English
3.Italiano
4.Portugues
5. 日本語



## 2. System Time

Set the system time for the inverter.

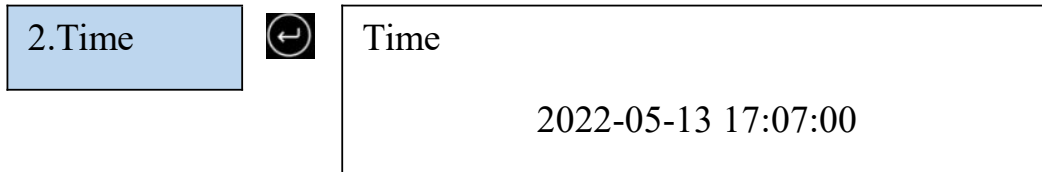

## 3. Safety Parameter.

User can modify the Safety Parameter. of the machine through the USB flash disk, and the user needs to copy the parameter information that needs to be modified into the USB flash disk card in advance.

Note:To enable this feature, please contact the SOFARSOLAR technical support.

## 4. Energy Storage Mode

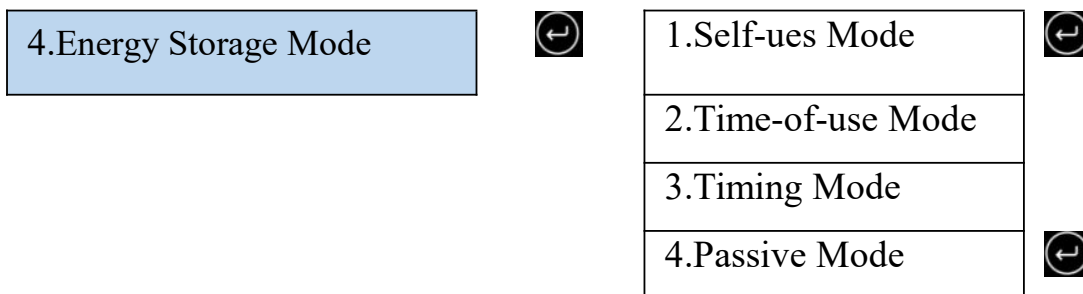

### 4.1 Self-ues Mode

In Self-use mode, inverter will automatically charge & discharge the battery.

<p>1) If PV power = load power (including emergency load and ordinary load), the inverter will not charge and discharge the battery.</p>	<p>2) If PV generation &gt; LOAD consumption, the surplus power will be stored in the battery.</p>
--	--

<p>3) If the battery is fully charged or has reached its maximum charging power, the remaining power is sent to the grid (with Anti-countercurrent enabled, the remaining power is not sent to the grid)</p>	<p>4) If the PV power is less than the load power, the inverter will supply power to the load through battery discharge.</p>
<p>5) If the PV power plus battery power is still less than the load power, the inverter will purchase power from the grid to supply power to the load.</p>	

### 4.2 Time-of-uses Mode

If electricity is more expensive in high demand time (peak rate) & electricity is much cheaper in low demand time (off-peak rate). You can select an off-peak period to charge your battery. Outside the off-peak charge period, inverter is working in Auto Mode.

If your family normally go to work/school on weekdays & stay at home on weekends, which means the home electricity consumption is much higher on weekends. Thus, you need to store some cheap electricity on weekends only. This is possible using our Time-of-use mode.

In summer, if your PV system can produce more electricity than your home electricity consumption. Then you don't need to set an off-peak charge period to charge your battery in summer at all. You can select an effective date (normally winter) for Time-of-use mode in this case. Outside the effective date, inverter is working in Auto Mode.

You can set multiple Time-of-use rules to meet your more complex requirement. Right now we support 4 rules maximum (rule 0/1/2/3).

2. Time-of-use Mode



Time-of-use Mode			
Rules. 0: Disabled			
From	To	SOC	Charge
02h00m	- 04h00m	070%	01000W
Effective Date			
Dec. 22	-	Mar. 21	
Weekday select			
Mon. Tue. Wed. Thu. Fri. Sat. Sun.			

4.3 Timing Mode

Changing the value of a rule can set multiple timing rules.



3.Timing Mode



Timing Mode	
Rules. 0: Enabled/Disabled	
Charge Start	22 h 00 m
Charge End	05 h 00 m
Charge Power	02000 W
DisCharge Start	14 h 00m
DisCharge End	16 h 00m
DisCharge Power	02500 W

4.4 Passive Mode

4.Passive Mode



For more detailed information, please ask representative of SOFAR to get a copy of passive mode communication protocol.

5. EPS Mode

5.EPS Mode



1.EPS Mode Control

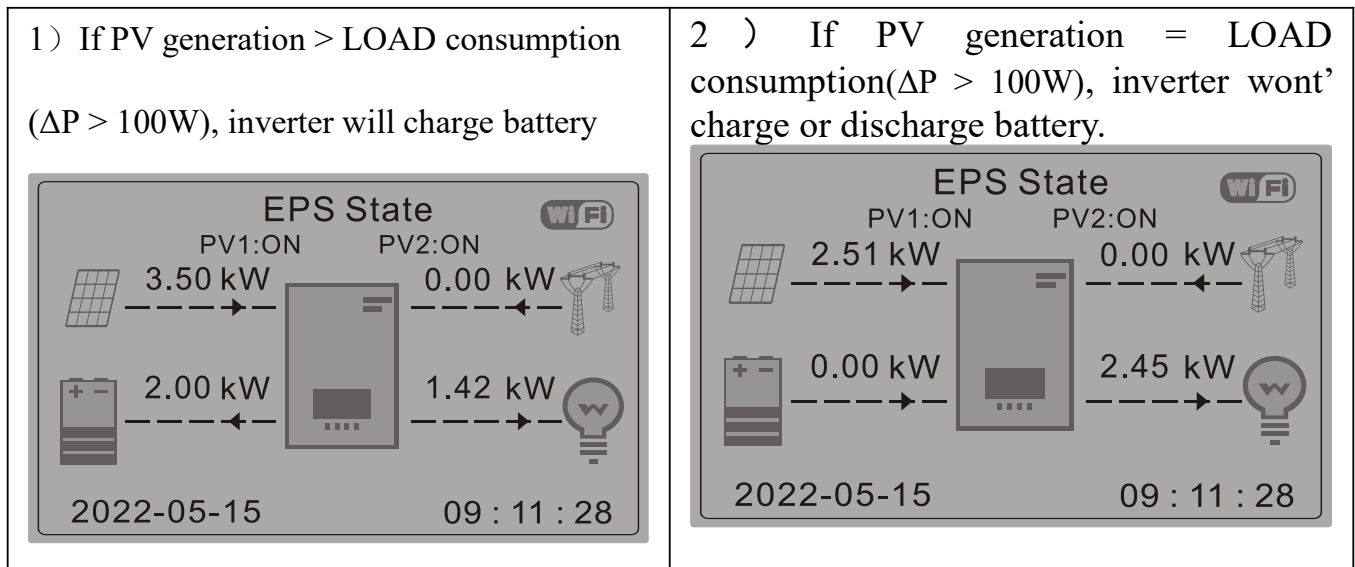

3) If PV generation < LOAD consumption  
( $\Delta P > 100W$ ), inverter will discharge  
battery.

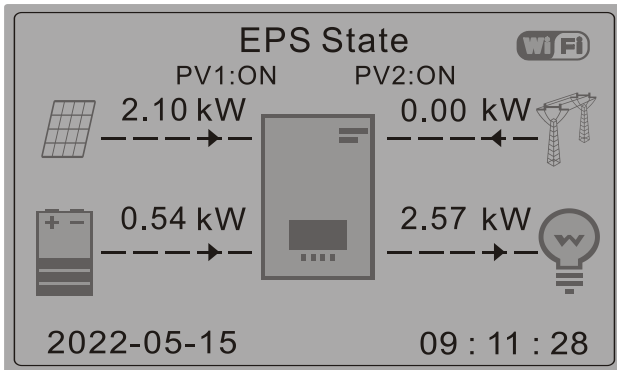

## 6. Communication Addr

6.Communication Addr



1.Communication Addr



2.Baud Rate



## 5.3.2. Advanced Setting

2.Advanced setting



**Input 0001**

1.Battery Parameter
2.Battery Activation
3.Anti Reflux
4.IV Curve Scan
5.Logic interface
6.Factory Reset
7.Parallel Setting
8. Reset Bluetooth
9.CT Calibration
10.Set ElevtricityMter

11.Off grid ground

### 1. Battery Parameter

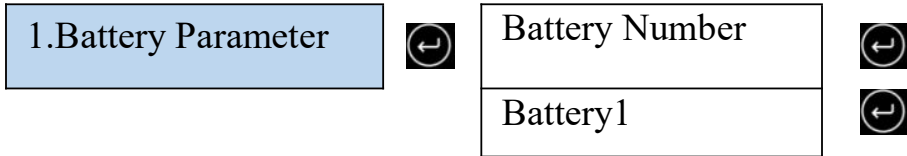

#### 1 Battery Quantity

Group 1 represents the number of cascading battery modules for the BAT1 port of the inverter.

Group 2 represents the number of battery modules connected to the BAT2 port of the inverter.

#### 2 Battery 1

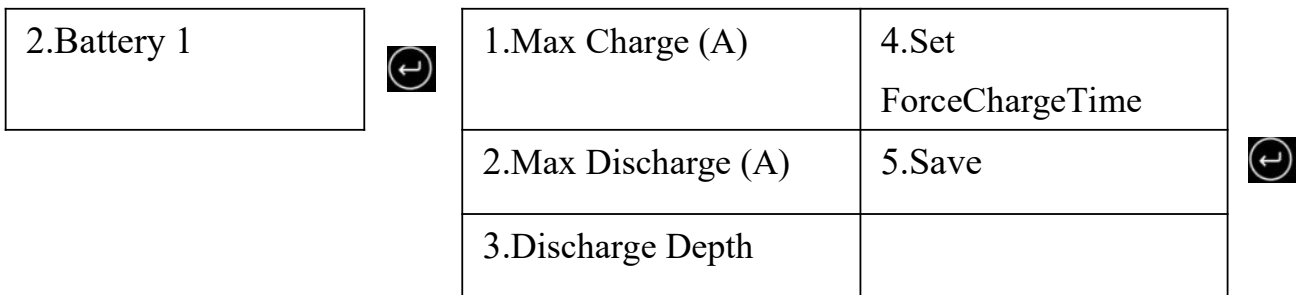

#### Depth of Discharge

For example: if Discharge Depth = 50% & EPS Discharge Depth = 80%.

While grid is connected: Inverter won't discharge the battery when its SOC is less than 50%.

In case of blackout: Inverter will work in EPS mode (if EPS mode is enabled) & keep discharging the battery till battery SOC is less than 20%.

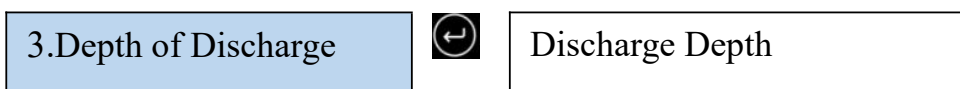

50%
EPS Discharge Depth
80%
EPS Safety Buffer
20%

## 2. Battery Activation



## 3. Anti Reflux

Users can limit the maximum power sent from the system to the grid by enabling Anti Reflux control. Counter current power is the maximum power expected to be sent to the grid (e.g., 0KW means no energy is fed into the grid).

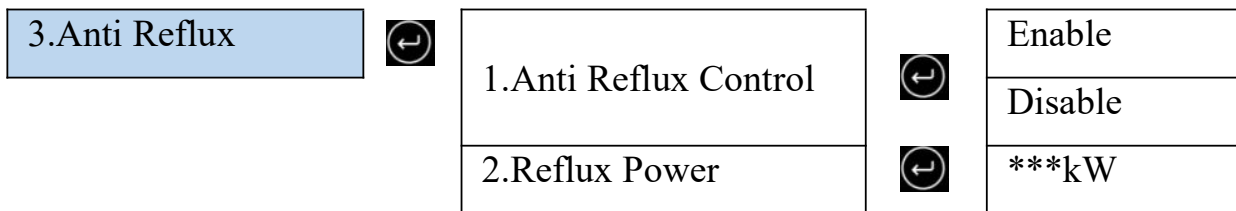

## 4. IV Curve Scan

When a component of PV modules is blocked or abnormal, multiple power peaks occur, the maximum power peaks can be traced by enabling this function.

The user can enter the scan period to make the inverter scan immediately.

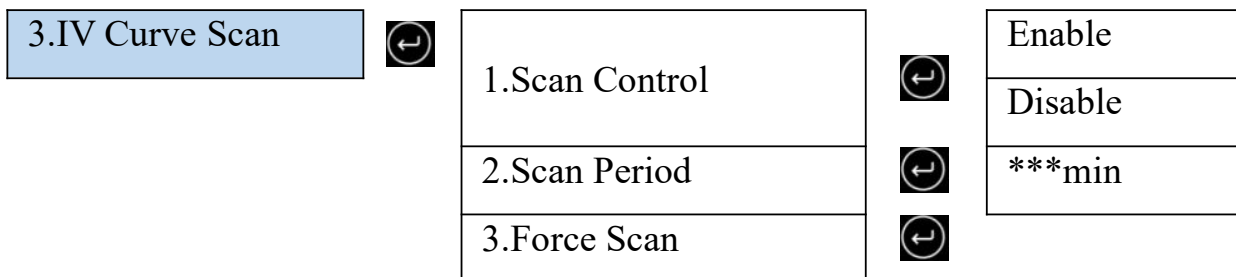

## 5. Logical Interface Control

Enables or disables a logical interface. This feature is only available under certain safety regulations.

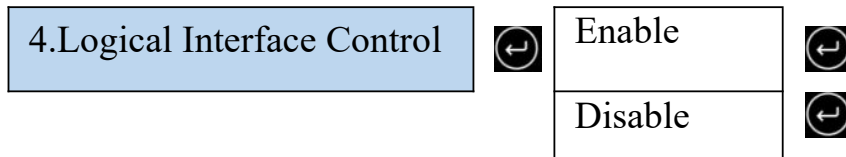

**6. Factory Reset**

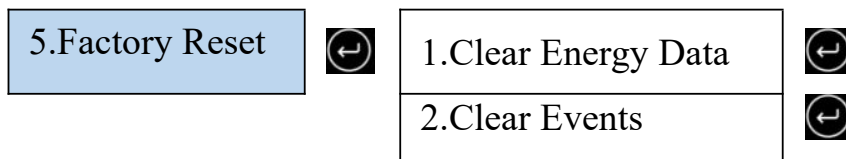

Clear the total energy yield of the inverter.

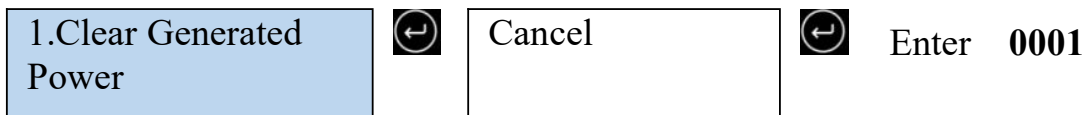

Clear the history events of the inverter.



**7. Parallel Setting**

For the parallel system, please refer to <4.6 Parallel System > .

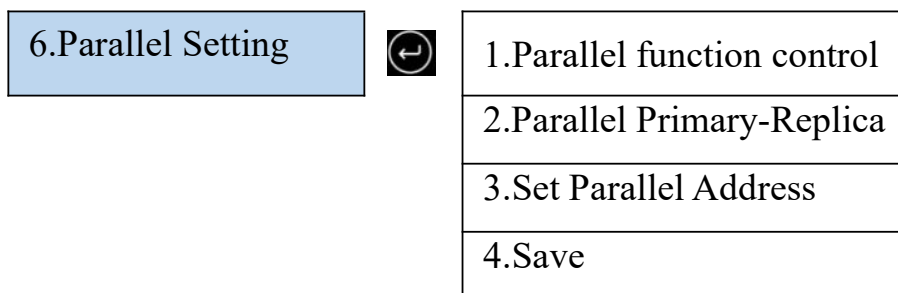

1. Parallel function control: Enable or disable the parallel function. This function must be enabled on both the master and slave machines.

2. Set master and slave: Set the master and slave. Select one inverter as the master and the others as slave machines.

3. Set parallel address: Set the parallel address for each inverter. In a parallel system, each inverter should have a parallel address that does not duplicate that of

other machines. (Note: Parallel addresses are different from communications addresses used for monitoring.)

4. Save: Be sure to save after the Settings.

### 8. Bluetooth Reset

7. Bluetooth Reset		Please Confirm!		Succeed
--------------------	--	-----------------	--	---------

### 9. CT Calibration

Used to calibrate the orientation and phase of the CT. The battery should be charged or discharged when using this feature.

8. CT Calibration		Start CT Calibration	Succeed/Failed
		Set CT Power Offset	***W

### 10. Set ElectricityMeter

10. Set ElectricityMeter		Disable
		Enable

### 11. Off grid ground

11. Off grid ground		Disable
		Enable





### 5.3.3. Energy Statistic

3. Energy Statistic		Today
---------------------	--	-------

	PV .....***kWh
	Load .....***kWh
	Export.....***kWh
	Import.....***kWh
	Charge.....***kWh
	Discharge.....***kWh
☑	<b>Month</b>
	PV .....***kWh
	Load .....***kWh
	Export.....***kWh
	Import.....***kWh
	Charge.....***kWh
	Discharge.....***kWh
☑	<b>Year</b>
	PV .....***kWh
	Load .....***kWh
	Export.....***kWh
	Import.....***kWh
	Charge.....***kWh
	Discharge.....***kWh
☑	<b>Lifetime</b>
	PV .....***kWh
	Load .....***kWh
	Export.....***kWh
	Import.....***kWh
	Charge.....***kWh
	Discharge.....***kWh

### 5.3.4. System Information



4..System Information		1.Inverter Info
		2.Battery Info
		3.Safety Info
		4.Debug Info
		3.PCU Info

1.Inverter Info		Inverter Info (1)
		Product SN
		Hardware Version
		Power Level
		Safety Firmware Version
		Inverter Info (2)
		Software Version
		Country
		Safety Lib Version
		Inverter Info (3)
		Input Channel 1
		Input Channel 2
		Input Channel 3
		Input Channel 4
		Inverter Info (4)
		Energy Storage Mode



	RS485 Address
	Inverter Info (5)
	Logic Interface
	Power Factor
	Inverter Info (6)
	Anti Reflux
	Insulation Resistance

2.Battery Info

	Battery 1 Info (1)
	Battery Type
	Battery Capacity
	Discharge Depth
	EPS Safety Buffer
	
Max Charge (A)	
Max Discharge (A)	
Charge Start	
Charge End	

3.Safety parameters.

	Safety param(1)
	OVP 1
	OVP 2
	UVP 1

	UVP 2
☑	Safety param (2)
	OFP 1
	OFP 2
	UFP 1
	UFP 2
☑	Safety param(3)
	OVP 10mins

### 5.3.5. Event List

Once a fault occurs, the fault information is displayed on the event list page. The event list displays the current event records, including the event ID and occurrence time of each event. You can access the event list screen on the main screen to view detailed information about real-time events. Events are listed by occurrence time, and the latest events are listed first.

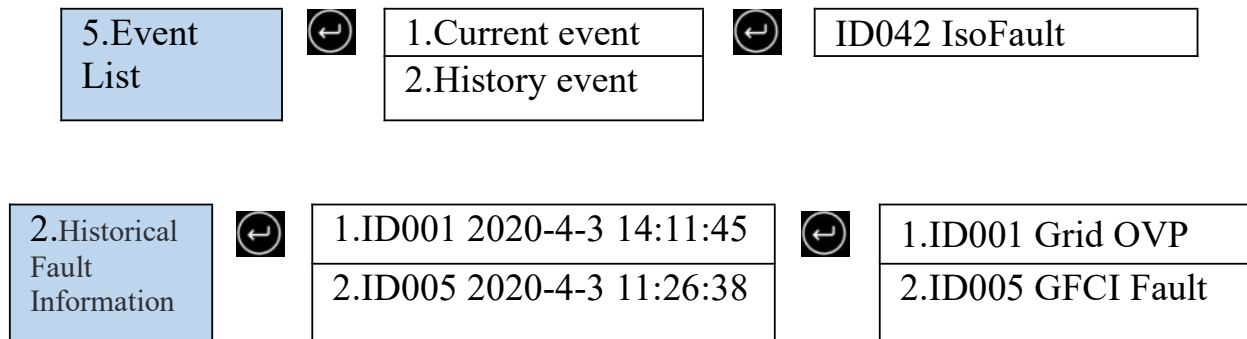

### 5.3.6. Software Update

You can upgrade the software using the USB flash drive to maximize the performance of the product and avoid abnormal operation caused by software bugs.

The upgrade file folder name is firmwareESI. These three upgrade file names are ESI\_ARM.bin, ESI\_DSPM.bin, ESI\_DSPS.bin.

Step 1 Insert the USB drive into the computer.

Step 2 SOFARSOLAR will send the upgraded firmware to the users who need to upgrade. After receiving the file, decompress it and save it in a USB flash drive.

Step 4 Insert the USB disk into the USB/Wifi interface of the machine.

Step 5 Turn on DC switch.

Step 6



Step 7 If the following error occurs, upgrade again. If this situation persists for several times, contact technical support for help.

USB error	DSPM file error	DSPS file error
ARM file error	Upgrading DSPM fail	Upgrading DSPS fail
Upgrading ARM fail		

Step 8 After the upgrading, turn off the DC switch, wait for the LCD screen to go off, then restore the WiFi connection, and then turn on the DC switch and AC switch again, and the inverter will enter the running state. You can view the current software version in System Info >> Software Version.

# 6. Trouble shooting and maintenance

## 6.1. Troubleshooting

- This section describes the potential errors for this product. Please read carefully for the following tips when doing the troubleshooting:
- View the warning or error information and error codes displayed on the display to record all error information
- If no error message is displayed on the LCD, perform the following steps to check whether the current installation status meets the operating requirements of the inverter:
  - Is inverter be installed in a clean, dry, ventilated environment?
  - Is the DC switch turn off?
  - Are the cable cross section area and length meet the requirement?
  - Are the input and output connection and wiring in good condition?
  - Are the configuration settings correctly for the particular installation?
  - Is the display panel properly connected to the communication cable and intact?
- To view the recorded fault information, perform the following steps: On the home screen, press "XXX" to enter the main menu. Select "Events" and press "XXXX" to enter.
- Ground fault alarm

The integrated inverters in this product comply with the ground fault alarm monitoring of IEC 62109-2 clause 13.9. If a grounding fault alarm occurs, the fault will be displayed on the LCD screen with red light on, and the fault can also

be found in the fault history. For the machine equipped with WiFi/4G data collector, the alarm information can be seen on the corresponding monitoring website or received through the APP on the mobile phone.

➤ Event list

Table 7-1 Event list

ID No.	Name	Solution
ID001	The grid voltage is too high	If the alarm occurs occasionally, the possible cause is that the electric grid is abnormal occasionally. Inverter will automatically return to normal operating status when the electric grid's back to normal.
ID002	The grid voltage is too low	
ID003	The grid frequency is too high	
ID004	The grid frequency is too low	If the alarm occurs frequently, check whether the grid voltage/frequency is within the acceptable range. If yes, please check the AC circuit breaker and AC wiring of the inverter.  If the grid voltage/frequency is NOT within the acceptable range and AC wiring is correct, but the alarm occurs repeatedly, contact SOFARSOLAR technical support to change the grid over-voltage, under-voltage, over-frequency, under-frequency protection points after obtaining approval from the

		local electrical grid operator.
ID005	Charge Leakage Fault	<p>Internal faults of inverter, switch OFF inverter, wait for 5 minutes, then switch ON inverter. Check whether the problem is solved.</p> <p>If not, please contact SOFARSOLAR technical support.</p>
ID006	OVRT function is faulty	
ID007	LVRT function is faulty	
ID008	Island protection error	
ID009	Transient overvoltage of grid voltage 1	
ID010	Transient overvoltage of grid voltage 2	
ID012	Inverter voltage error	
ID017	Power grid current sampling error	
ID018	Wrong sampling of dc component of grid current	
ID019	Power grid voltage sampling error (DC)	
ID020	Power grid voltage sampling error (AC)	
ID022	Leakage current sampling error(AC)	
ID024	Input current sampling error	
ID025	DCI sampling error(AC)	
ID026	Branch current sampling	

ID029	Leakage current consistency error	
ID030	Grid voltage consistency error	
ID031	DCI consistency error	
ID032	Offgrid ground fault	
ID034	SPI communication error (AC)	
ID036	Chip error (AC)	
ID038	Inverter soft startup fails	
ID042	Low insulation impedance	Check the insulation resistance between the photovoltaic array and ground (ground), if there is a short circuit, the fault should be repaired in time. If not solved, please contact SOFARSOLAR technical support.
ID043	Ground fault	Check ac output PE wire for grounding.
ID044	Error setting input mode	Check the PV input mode (parallel/independent mode) setting of the inverter. If not, change the PV input mode
ID045	CT Fault	Check whether the CT connection is correct
ID046	Input reverse connection error	Check whether the DC input

		connection is correct
ID047	Parallel Fault	<p>Check whether parallel is enabled</p> <p>Check whether parallel addresses overlap</p> <p>Check whether the parallel network is connected properly</p>
ID048	SN doesn't match Type	please contact SOFARSOLAR technical support.
ID050	Radiator 1 temperature protection	Make sure the inverter is installed in a place free from direct sunlight.
ID057	Temperature 1 protection	<p>Make sure the inverter is installed in a cool/well-ventilated place.</p> <p>Ensure that the inverter is installed vertically and the ambient temperature is lower than the upper limit of the inverter temperature.</p>
ID065	Unbalanced bus voltage RMS	Internal faults of inverter, switch OFF inverter, wait for 5 minutes, then switch ON inverter. Check whether the problem is solved.
ID066	The transient value of bus voltage is unbalanced	
ID067	Bus undervoltage during grid connection	
ID069	PV over-voltage	Check whether the PV series voltage (Voc) is higher than the



		maximum input voltage of the inverter. If yes, adjust the number of PV modules in series and reduce the PV string voltage to fit the input voltage range of the inverter. After correction, the inverter will automatically return to normal state.
ID070	Bat over-voltage	Check whether the battery overvoltage Settings are inconsistent with battery specifications
ID072	Inverter bus voltage RMS software overvoltage	Internal faults of inverter, switch OFF inverter, wait for 5 minutes, then switch ON inverter. Check whether the problem is solved.  If not, please contact SOFARSOLAR technical support.
ID073	Inverter bus voltage instantaneous value software overvoltage	
ID081	Battery overcurrent protection by software	
ID082	Dci overcurrent protection	
ID083	Output instantaneous current protection	
ID085	Output effective value current protection	
ID086	PV overcurrent software	

	protection	
ID087	PV flows in uneven parallel	
ID098	Inverter bus hardware overvoltage	
ID099	BuckBoosthardware overflows	
ID100	Reserved	
ID102	PV hardware overflows	
ID103	Ac output hardware overflows	
ID105	Meters communication fault	<p>Check whether the meter is enabled</p> <p>Check whether the meter wiring is correct</p>
ID107	Hardware version error	<p>Internal faults of inverter, switch OFF inverter, wait for 5 minutes, then switch ON inverter. Check whether the problem is solved.</p> <p>If not, please contact SOFARSOLAR technical support</p>
ID110	Overload Protection 1	Check whether the inverter works in overload state.
ID111	Overload Protection 2	
ID112	Overload Protection 3	
ID113	Overtemperature derating	Make sure the inverter is installed in a place free from direct

		<p>sunlight.</p> <p>Make sure the inverter is installed in a cool/well-ventilated place.</p> <p>Ensure that the inverter is installed vertically and the ambient temperature is lower than the upper limit of the inverter temperature.</p>
ID114	Frequency derating	Make sure the grid frequency and voltage are within acceptable range.
ID124	Battery low voltage protection	Check whether the battery voltage is too low or the battery discharge depth is too low.
ID130	Permanent Bus overvoltage failure	<p>Internal faults of inverter, switch OFF inverter, wait for 5 minutes, then switch ON inverter. Check whether the problem is solved.</p> <p>If not, please contact SOFARSOLAR technical support.</p>
ID132	PV unbalance current permanent fault	
ID134	Output current imbalance permanent fault	
ID138	Output hardware overcurrent permanent failure	<p>Internal faults of inverter, switch OFF inverter, wait for 5 minutes, then switch ON inverter. Check whether the problem is solved.</p> <p>If not, please contact</p>

		SOFARSOLAR technical support.
		Internal faults of inverter, switch OFF inverter, wait for 5 minutes, then switch ON inverter. Check whether the problem is solved.
ID140	Relay permanent fault	If not, please contact SOFARSOLAR technical support.
		Internal faults of inverter, switch OFF inverter, wait for 5 minutes, then switch ON inverter. Check whether the problem is solved.
ID142	DC SPD failure	If not, please contact SOFARSOLAR technical support.
		Internal faults of inverter, switch OFF inverter, wait for 5 minutes, then switch ON inverter. Check whether the problem is solved.
ID144	Grid relay permanent fault	If not, please contact SOFARSOLAR technical support.
		Internal faults of inverter, switch OFF inverter, wait for 5 minutes, then switch ON inverter. Check whether the problem is solved.
ID152	The software version is inconsistent with the safety version	If not, please contact SOFARSOLAR technical support.
ID153	SCI communication error (DC)	Contact technical support to
ID156	Inconsistent software versions	

		obtain the upgrade software.
ID157	Lithium battery 1 communication error	<p>Make sure the battery you use is compatible with the inverter.</p> <p>CAN communication is recommended. Check whether the communication cable or port between the battery and the inverter is faulty.</p>
ID161	Force shutdown	The inverter is forced to shut down.
ID162	Remote shutdown	The inverter is shut down remotely.
ID163	Drms0 shutdown	The inverter is Drms0 shut down
ID165	Remote derating	The inverter is derating remotely
ID166	Logic interface derating	The inverter is Logic interface derating
ID167	Anti refluxderating	The inverter is Anti refluxderating
ID169	Fan 1 fault	Check whether fan 1 of the inverter works properly
ID170	Fan 2fault	Check whether fan 2 of the inverter works properly
ID171	Fan 3 fault	Check whether fan 3 of the inverter works properly
ID172	Fan 4 fault	Check whether fan 4 of the inverter works properly

ID173	Fan 5 fault	Check whether fan 5 of the inverter works properly
ID174	Fan 6 fault	Check whether fan 6 of the inverter works properly
ID175	Fan 7 Fault	Check whether fan 7 of the inverter works properly
ID176	Communication failure of electricity meter	<p>Make sure the battery you use is compatible with the inverter.</p> <p>CAN communication is recommended. Check whether the communication cable or port between the battery and the inverter is faulty.</p>
ID177	BMS over-voltage alarm	<p>The lithium battery is faulty. Shut down the inverter and lithium battery. Wait for 5 minutes and start the inverter and lithium battery. Check whether the problem is rectified. If not, contact technical support.</p>
ID178	BMS under-voltage alarm	
ID179	BMS high temperature alarm	
ID180	BMS low temperature alarm	
ID181	BMS over-current alarm	
ID182	BMS Short circuit alarms	
ID183	BMS Version inconsistency	
ID184	BMSCAN Version inconsistency	

ID185	BMS CAN Version is too low	
ID189	Communication failure of arc equipment	Reserved
ID401 ~ ID432	Acr fault	
ID 801	The charging soft start failed	
ID 802	The discharging soft start failed	Restart the battery. If the problem is not resolved, please contact technical support .
ID 807	Pcu version inconsistency	Check whether the number of batteries is set correctly. If the setting is correct, please contact technical support to upgrade software.
ID 808	Radiator 1 high temperature alarm	Please make sure the battery is installed in a cool well-ventilated place. If The battery is installed correctly, please contact technical support .
ID 809	Ambient high temperature alarm	
ID 813	Charging prohibition alarm	If the battery is almost fully, no action is required. Otherwise, please contact technical support .
ID 814	Discharging prohibition alarm	If the battery is almost empty, no action is required. Otherwise, please contact technical support .
ID 864	Over temperature protection of radiator 1	Power off and wait for 2 hours. If the problem is not solved, please

		contact technical support.
ID 865	Over temperature protection of ambient temperature	
ID 867	Can1 communication failure	If this fault occurs occasionally, wait a few minutes to see whether the problem is solved. If this fault occurs frequently, please contact technical support.
ID 872	Bus software overvoltage	
ID 873	Bus software undervoltage	
ID 874	Battery software overvoltage	
ID 875	Battery software undervoltage	
ID 876	Battery software overcurrent	
ID 879	Hardware overcurrent	
ID 880	Permanent bus overvoltage	Restart the battery and wait for minutes. If the problem is not resolved, please contact technical support.
ID 881	Permanent battery undervoltage	
ID 882	Permanent Instant overcurrent	
ID 883	Permanent hardware overcurrent	
ID 894	Permanent battery activation failed	
ID 895	Permanent bus reverse connection	Check whether the wiring is correct and restart the battery. If the problem is not resolved, please contact technical support.
ID 896	Battery status error	Restart the battery. If the problem



ID 897	PWM mode error	is not resolved, please contact technical support.
ID 898	BMS version error	
ID 899	BMS overvoltage and overcurrent fault	If this fault occurs occasionally, wait a few minutes to see whether the problem is solved. If this fault occurs frequently, please contact technical support.
ID 900	Battery average overcurrent protection	
ID 901	Average overload protection	
ID 902	Bus software overcurrent	
ID 903	Software CBC overcurrent protection	
ID 904	Pack ID error	Restart the battery and wait for seconds. If the problem is not resolved, please contact technical support.
ID 928	Battery reversal	Check whether the wiring is correct and restart the battery. If the problem is not resolved, please contact technical support.
ID 929	Fusing failure	Restart the battery. If the problem is not resolved or occurs frequently, please contact technical support.

## 6.2. Daily Maintenance

This product usually does not require maintenance or calibration, but ensure that the inverter and the heat sink of the battery module are not covered by dust or dirt.

- Clean the inverter and battery modules:

Please clean the inverter with an air blower, a dry & soft cloth or a soft bristle brush. Do NOT clean the inverter with water, corrosive chemicals, detergent, etc.

- Clean radiator:

In order to ensure the normal function and long service life of the product, it is necessary to ensure that there is enough air flow space around the radiator at the rear of the product, and there is no material around the radiator that obstructs the air flow, such as dust or snow, must be removed. Clean the radiator with compressed air, a soft cloth, or a soft brush. Do not use water, corrosive chemicals, cleaning agents, or strong detergents to clean the heat sink.

## 6.3. Store and charge the battery module

Battery module storage requirements:

- Environment temperature:  $-10^{\circ}\text{C}\sim 50^{\circ}\text{C}$ , Recommended storage temperature:  $25^{\circ}\text{C}\sim 35^{\circ}\text{C}$ .
- Storage relative humidity range:  $5\%\sim 70\%$ .
- Store in a dry, clean, and ventilated environment, away from direct sunlight.
- If the battery module is stored for a long time, replenish the power supply periodically. Battery module power supply requirements: the charging current is less than or equal to 7A, and the battery module needs to be charged to 50%SOC.

### ➤ Recharge Requirements During Normal Storage

When the battery is stored for a long time, you need to perform regular maintenance. If the storage time is close to that shown in the following table, arrange supplementary power supply in time.

Recharge conditions when in storage

Storage Environment Temperature	Relative Humidity of Storage Environment	Storage Time	SOC
< -10°C	/	Prohibit	/
-10°C~25°C	5%~70%	≤12 months	30%≤SOC≤60%
25°C~35°C	5%~70%	≤6 months	30%≤SOC≤60%
35°C~45°C	5%~70%	≤3 months	30%≤SOC≤60%
> 45°C	/	Prohibit	/

### ➤ Recharge Requirements When Over Discharged

Recharge the battery within the time range specified in the following table (90%DOD). Otherwise, the overdischarged battery module will be damaged.

Recharge conditions when battery is over discharged

Storage Environment Temperature	Storage Time	Note

-10°C~25°C	≤15 days	/
25°C~45°C	≤7 days	30%≤SOC≤60%
-10°C~45°C	≤12 hours	/

# 7. Technical Parameters

System Parameters							
System Schematic							
Rated output power	3000~6000W						
Qty.of batteries	1	2	3	4	5	6	
Battery total energy[1]	5kWh	10kWh	15kWh	20kWh	25kWh	30kWh	
Degree of protection	IP65						
Ambient temperature range[2]	-10°C~+50°C						
Allowable relative humidity range	5%~95%						
Max. operating altitude[3]	4000m						
Weight	74.5kg	125.5kg	176.5kg	228.5kg	279.5kg	330.5kg	
Dimension(W*D*H)	708*170*890 mm	708*170*13 10mm	708*170*17 30mm	708*170*13 10mm	708*170*13 10mm	708*170*17 30mm	

					708*170*90 0mm	708*170*13 20mm	708*170*13 20mm	
Display	LCD & APP+Bluetooth							
Communication	RS485/Bluetooth/Ethernet, Optional: WiFi//4G/GPRS							
<b>Inverter Module</b>								
Model	ESI 3K-S1	ESI 3.68K-S1	ESI 4K-S1	ESI 4.6K-S1	ESI 5K-S1	ESI 5K-S1-A	ESI 6K-S1	
Rated battery voltage	400V							
Max. charge/discharge current	20A							
Max. PV input power	4500Wp	5400Wp	6000Wp	6900Wp	7500Wp	7500Wp	9000Wp	
Max. input voltage	550V							
Rated input voltage	360V							
Full power input voltage	140V-500V	170V-500V	185V~500V	215V~500V	235V~500V	235V~500V	280V~500V	
MPPT operating voltage range	85~520V							
Number of MPP trackers	2							
Max. input current per MPPT	16A/16A							

Rated grid voltage	L/N/PE, 220V/230V/ 240V,50Hz / 60Hz						
Grid voltage range	180Vac-276Vac (According to local standard)						
Rated AC power	3000W	3680W	4000W	4600W	5000W	5000W	6000W
Max. AC power output to utility grid	3300VA	3680VA	4400VA	4600VA	5500VA	5000VA	6600VA
Max. AC Current Output to Utility Grid (A)	14.3A	16A	19.1A	20A	23.9A	21.7A	28.9A
Rated voltage,Frequency(Off-grid)	220V/230V, 50/60Hz						
Max. apparent power(Off-grid)	3000VA	3680VA	4000VA	4600VA	5000VA	5000VA	6000VA
Peak output power,Duration(Off-grid)	4500VA, 10S	5520VA, 10S	6000VA , 10S	6900VA, 10S	7500VA, 10S	7500VA, 10S	9000VA, 10S
Switch time	< 10ms						
Max efficiency of solar inverter	97.70%	97.70%	97.70%	97.80%	97.80%	97.80%	97.80%
European efficiency of solar inverter	97.00%	97.00%	97.00%	97.10%	97.10%	97.10%	97.10%
Topology	Transformerless						
Dimension(W*D*H)	708*170*410mm						
Weight	22.5kg						

## Battery Module

Model	BTS 5K
Battery Type	LFP
Battery module energy	5120Wh
Depth of discharge (DOD)	0~90% adjustable
Rated Power	2500W
Topology	Transformer isolation
Dimension(W*D*H)	708*170*420mm
Weight	50kg
Certification	UN38.3, IEC62619, IEC62040-1, SAA etc.

## Certification

EMC	EN 61000-6-2, EN 61000-6-3, EN 61000-3-2, EN 61000-3-3, EN 61000-3-11, EN 61000-3-12
Safety standards	IEC 62109-1/2, IEC 62040-1, IEC 62116, IEC 61727, IEC 61683, IEC 60068(1,2,14,30),UN38.3,IEC62619,SAA
Grid standards	VDE-AR-N 4105, VDE V 0126-1-1, AS/NZS 4777, CEI 0-21, G98/G99, TR321,TR322, EN 50438/EN50549, UTE C15-712-1, NRS 097-2-1, UNE 206 007-1

1. Test condition: 0.2C charge/discharge, 25°C, 100%DOD
2. Refer to the temperature derating curve.



3. If the altitude is  $>2000\text{m}$ , derating operation is required, refer to the derating curve.
4. Rated AC power 4600 for VDE-AR-N 4105, 5000 for Australia, 6000 for other country
5. Max. AC power output to utility grid 4600 for VDE-AR-N 4105, 5000 for Australia, 4048/5500/6600 for Italy, 3680/ 5000/6000 for other country.
6. 4600 for VDE-AR-N 4105, 5500 for Italy, 5000 for other country.
7. 4048 for Italy, 3680VA for other countries.
8. 21.7A for Australia.
9. Italy is 1.1 times overloaded

## 8. Manufacturer's Warranty and Liability Terms

### **SOFAR standard warranty document**

Warranty period and calculation method of SOFARSOLAR battery products refer to the Quality Assurance Agreement of SOFARSOLAR ESI Series Household Energy Storage System.

### **Extended warranty period**

If the purchased battery exceeds the warranty period stipulated in the Warranty Agreement of SOFARSOLAR ESI Series Household Energy Storage System, the customer can apply for the extended warranty period by providing the serial number of the product to the sales team of the company, and the Company has the right to reject the purchase application for the extended warranty period that does not meet the requirements.

If the original buyer wants to apply for the extended warranty service, please contact the sales team of SHENZHEN SOFARSOLAR Co., LTD to purchase the products that exceed the extended warranty period but have not passed the warranty period stipulated in the Warranty Agreement of SOFARSOLAR ESI Series Household Energy Storage System, the original buyer shall bear different extended premiums.

Upon purchase of the extended warranty service, our company will issue an extended warranty card to the customer to confirm the extended warranty period.

### **Invalid warranty clause**

Equipment failure caused by the following reasons is not covered by the warranty:

- 1) The "warranty card" has not been sent to the distributor or Shenzhen SOFARSOLAR Co., LTD;
- 2) Without the consent of SHENZHEN SOFARSOLAR Co., LTD to change equipment or replace parts;
- 3) Use unqualified materials to support SHENZHEN SOFARSOLAR Co., LTD 's products, resulting in product failure;
- 4) Technicians who don't belong to SOFARSOLAR Co., LTD modify or attempt to repair and erase the product serial number or silk screen;
- 5) Incorrect installation, debugging and use methods;
- 6) Failure to comply with safety regulations (certification standards, etc.);
- 7) Damage caused by improper storage by dealers or end users;
- 8) Transportation damage (including scratches caused by internal packaging during transportation).Please claim directly from the transportation company or insurance company as soon as possible and obtain damage identification such as container/package unloading;
- 9) Failure to follow the product user manual, installation manual and maintenance guidelines;
- 10) Improper use or misuse of the device;
- 11) Poor ventilation of the device;
- 12) The product maintenance process does not follow relevant standards;
- 13) Failure or damage caused by natural disasters or other force (such as earthquake, lightning strike, fire, etc.)



ENERGY TO POWER YOUR LIFE

**ADDRESS**

11th Floor, Gaoxingqi Technology Building,  
District 67, Xingdong Community, Xin'an Street,  
Bao'an District, Shenzhen, China

**EMAIL**

info@sofarsolar.com

**WEBSITE**

www.sofarsolar.com

